



THE SWITCHES AND SOCKETS

COLLECTION

THE SOHO LIGHTING CO.

Luxury is an often indefinable quality, the unmistakable mark of distinction, a realm *above the ordinary*.

Our philosophy is to design and create luxury lighting and accessories that are expertly and sustainably crafted to offer exceptional quality.

Our sockets and switches are *beautifully designed and meticulously engineered* and powered by award-winning Enkin technology, seamlessly blending aesthetic appeal and functionality.

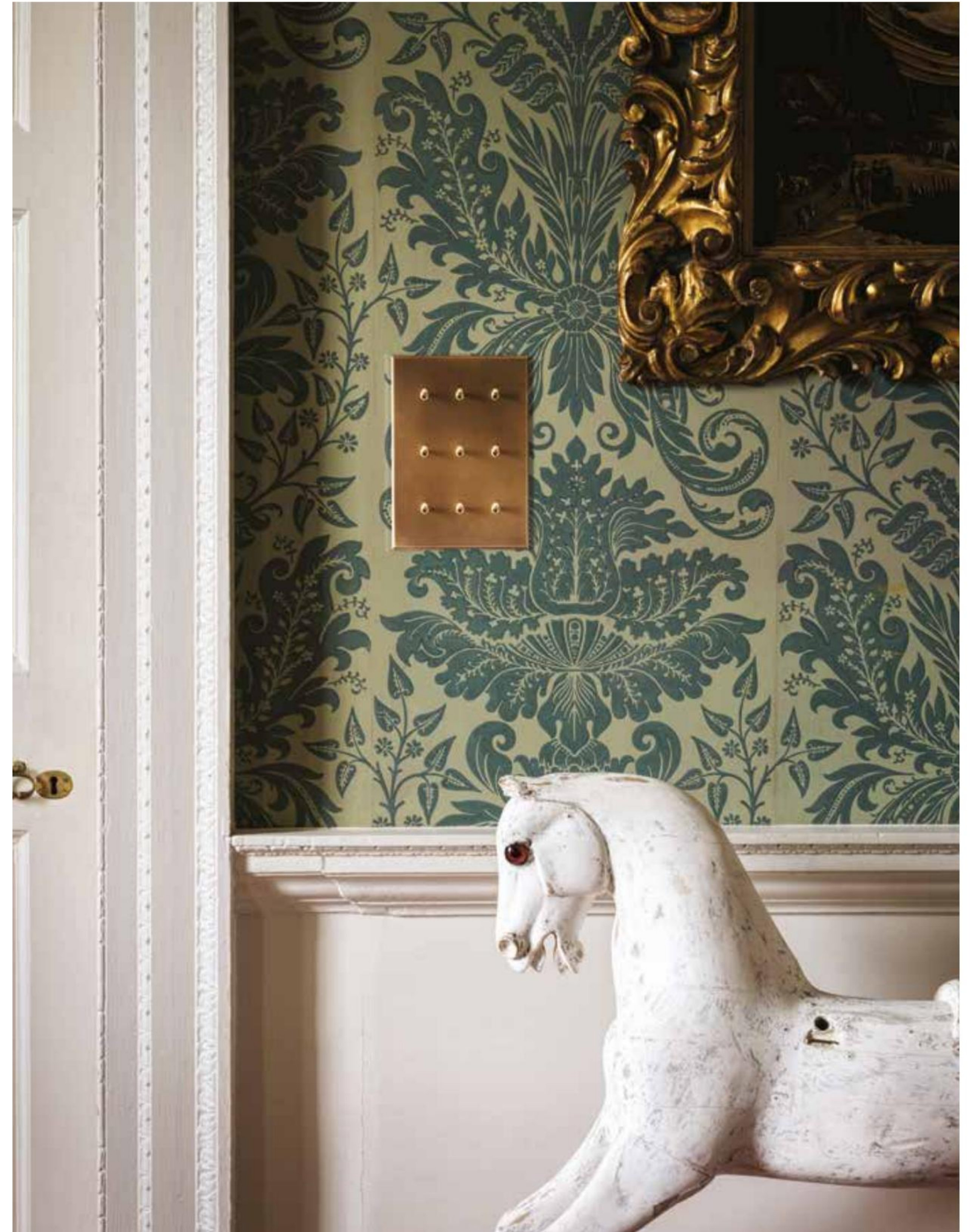

CONTENTS

ABOUT US

- Contents – p.02
- About Us – p.05
- Our Design Philosophy – p.06
- Pioneering Circularity in Design – p.08
- Innovation in Lighting – p.10
- The story of The Palaces Collection – p.12

BESPOKE OPTIONS P.14

- Bespoke Engraving Service – p.16

CREATE YOUR PERFECT SWITCH P.18

OUR PERSONAL SERVICE P.20

- Our Integrated Approach – p.22
- Independent Lighting Plan Consultancy – p.23
- Residential Case Study – p.24
- Commercial Case Study – p.26

OUR COLLECTIONS P.28

- Our Plate Styles – p.28
- Our Decorative Switch Options – p.30
- Traditional and Flat Plate Finishes – p.32
- The Charterhouse Collection – p.34
- The Savoy Collection – p.36
- The Westminster Collection – p.38
- The Belgravia Collection – p.40
- The Eton Collection – p.42
- The Sloane Collection – p.44
- The Chiswick Collection – p.46
- The Camden Collection – p.48
- The Lombard Collection – p.50
- The Finbury Collection – p.52
- The Connaught Collection – p.54
- The Paintable Collection – p.56
- The Elden Collection – p.58

Historic Royal Palaces: The Palaces Collection – p.60

- Aged Brass – p.62
- Natural Brass – p.64
- Heritage Bronze – p.66
- Coming Soon:* Liquid Gold – p.68
- Coming Soon:* Nickel – p.70

Outdoor Switches And Sockets – p.72

EXPLORE INFINITE POSSIBILITIES P.74-92

- Frequently Asked Questions – p.93
- Become a Trade Member – p.96

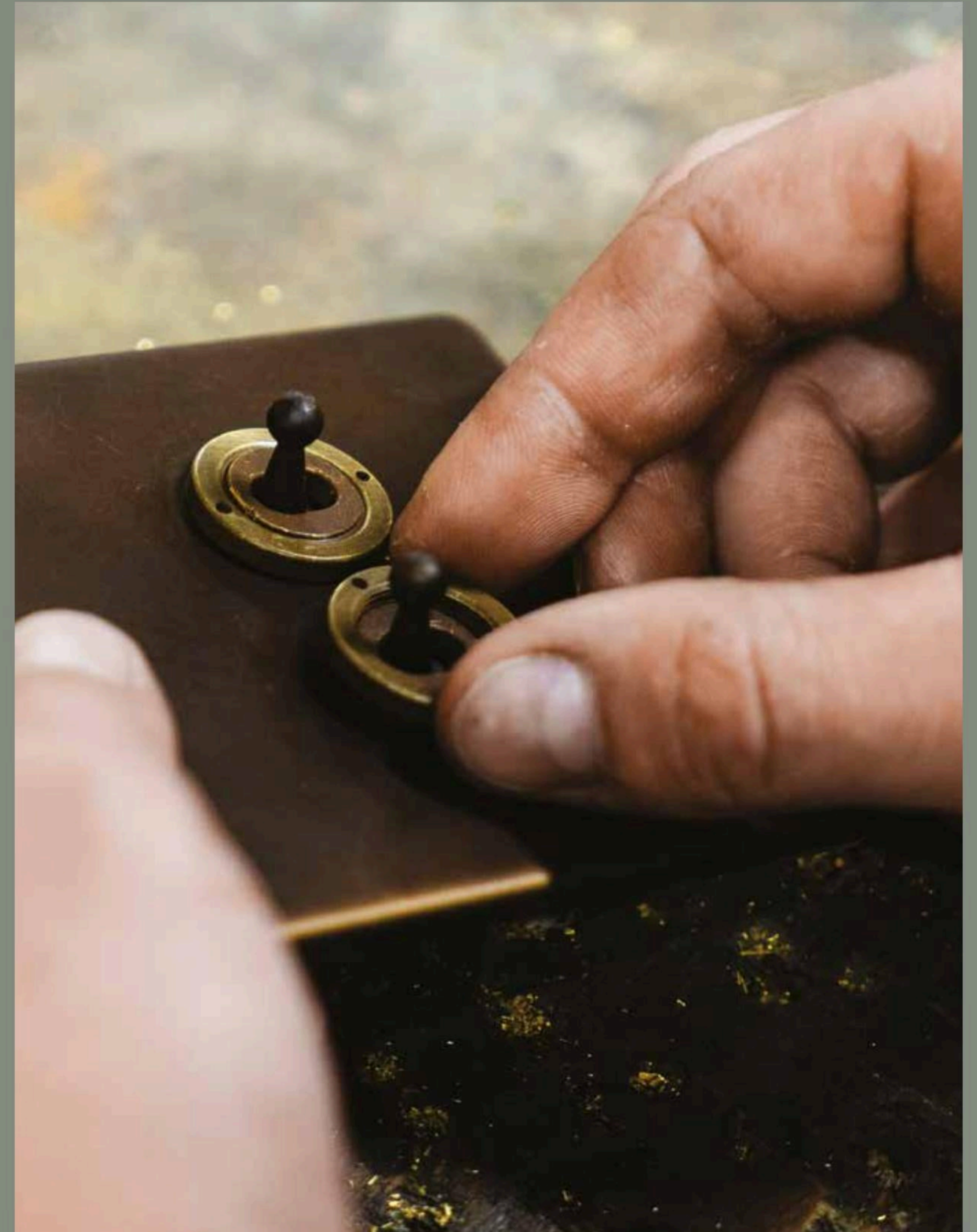



CO-FOUNDER
LEE LOVETT

A passion for lighting led to
the creation of the company.

ABOUT US

Our story begins in Soho, London in 2017. We struggled to find the right lighting and switches for our own renovation projects, refurbishing historical buildings in one of the capital's most characterful neighbourhoods.

Passionate about interior design and with a firm belief in the transformative power of lighting, we saw an opportunity to create beautiful lighting, switches and sockets inspired by period properties yet adapted and technically enhanced for modern living.

Pieces that elevate and enlighten, are reliable, high performing and responsibly made; that offer more than just good looks, marrying form with function for visual comfort and pitch perfect ambiance. So we set up The Soho Lighting Company, creating superior lighting, switches and sockets enabled by innovative technology to help you bring your home to life.

“Lighting can make or break even the most carefully designed interior. It is both an art and a science, with the ability to elevate a space and reveal its true potential.”

Lee Lovett, co-Founder & Creative Director

OUR
Design
philosophy

It's in the detail...

We engage more with switches and sockets than any other design feature within an interior.

Our switches and sockets are available in 12 exquisite finishes and three distinctive plate styles – traditional, minimalist, and historically inspired allowing you to create a truly unique and luxurious interior scheme where every detail is carefully curated.

From traditional finishes like Antique and Vintage Brass, paintable plates that seamlessly disappear into your paintwork, to more contemporary White Metal, you have a wealth of choice at your fingertips.

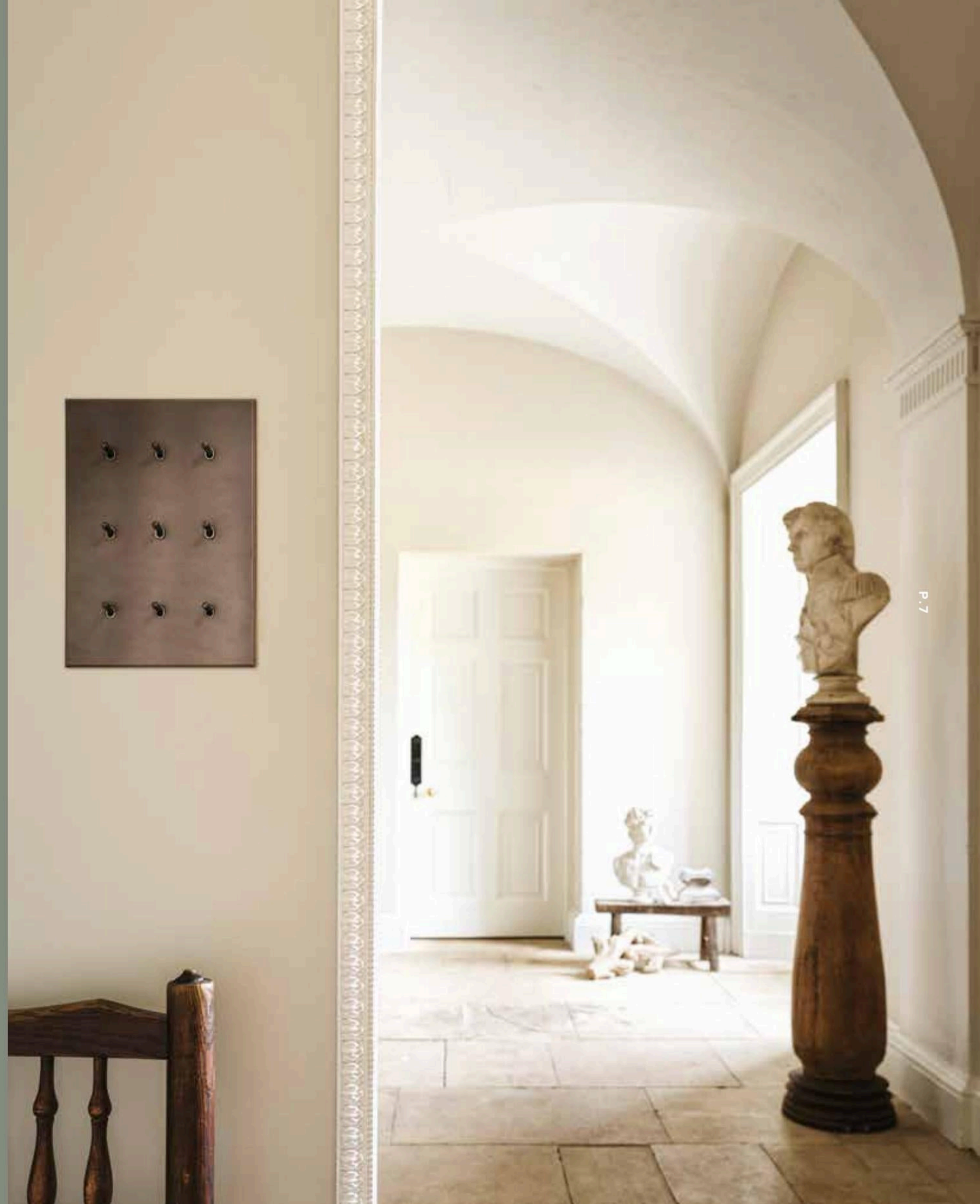



Our dedication to sustainability extends beyond our products to encompass people, the planet and our community.

Pioneering circularity in design



Sustainable quality without compromise

At Soho Lighting, our product design, development and manufacturing are guided by a deep respect for tradition and a profound understanding of the finite nature of our global resources. We embrace the timeless values of “built to last” and recognise the importance of responsible production. We are on a journey towards B Corp accreditation and are proud to have recently become carbon neutral.

Designing for longevity

From the very beginning, we rejected the modern approach of creating sealed, unrepairable units, driven by economy over style. Instead, we opted for our unique design philosophy that ensures durability and serviceability at every stage of the process. Our switches are built with a robust solid metal backplate utilising the highest quality materials and components. Each product is meticulously assembled, tested and finished by hand, undergoing a rigorous final inspection to meet our exacting standards.

Reducing plastic waste

Our dedication to sustainability extends beyond our products to our packaging. We’ve taken strides to reduce plastic waste, achieving a remarkable 97% reduction in plastic use in our packaging materials. It’s a small step towards a greener future, but every step counts.

Peace of mind, guaranteed

We believe in the longevity of our products, and we back it up with a 15-year guarantee offered as standard on most of our items. This guarantee not only ensures outstanding looks, performance and durability but also provides enduring peace of mind to you, our valued customers. By choosing Soho Lighting, you’re not just investing in quality, you’re joining us on a journey toward a more sustainable and responsible future.

Dimming at Soho Lighting

We are electrical engineers. We are proudly partnered with Enkin technology who design and engineer all the electronic function behind our switch and sockets.

ENKIN

THE SOHO LIGHTING CO.

Our pioneering dimming technology has been designed by our award-winning technology partner, Enkin, to eradicate the compatibility and buzzing issues so often found with dimming switches. Choose from four elegant dimming solutions:

The Smart Dimming Toggle

Our Smart Dimming Toggles now boast voice and phone app-activation, game-changing technology that brings the benefits of home automation without the costly and complex installation, enabling you to voice activate our lighting, control it from your tablet or phone from any location or more traditionally dim your lighting from your toggle switch.

The Rotary

The traditional dimming choice, the Rotary exudes tactile elegance, offering seamless control. Its smooth rotation embodies intuitive design, blending functionality with aesthetic refinement.

The Dimming Toggle

Our original dimming toggle which, since its launch in 2022, has pioneered the market, melding the functional aspect of a dimmer with the elegance of a toggle. Our dimming toggles have revolutionised the way we light our homes; their multi-locational capability means you can separately dim from any number of toggles in the same room, allowing you to change the atmosphere, vitality and ambiance of a space at the flick of a switch.

The Push Button

An elegant addition to our dimming collection, the Push Button offers a sleek, modern design for those who love a contemporary aesthetic. The clean lines and smooth button give a pared-back, sophisticated feel, alongside its practical functionality.



The Smart Dimming Toggle



The Rotary



The Dimming Toggle



The Push Button



P 11

The beauty of the past, reimagined

SOHO LIGHTING X HISTORIC ROYAL PALACES

Following two years of exploration behind the scenes of historic treasures at Hampton Court Palace and Kensington Palace, The Palaces Collection takes its inspiration from the architecture, interiors and gardens of the palaces; extracting the essence of a pattern, an artefact, a finish, switch, socket or light to create a collection that reflects the history and character of these beautiful spaces.

THE SOHO LIGHTING CO.



Behind the design

Marrying elegant aesthetics and innovative technology, the panel-mounted plates are a faithful representation of original hardware and finishes found in the palaces. Handcrafted from solid brass and sitting flush to the wall, they are traditional in style but backed by cutting-edge functionality.

The state-of-the-art MagnaTec™ plate system dramatically simplifies installation whilst creating a truly flawless and screwless finish. Available in three stunning finishes – Natural Brass, Aged Brass and Heritage Bronze - the collection is set to evolve further with additional finishes, toggle designs and lighting. Our Bespoke Engraving service offers a further mark of distinction.

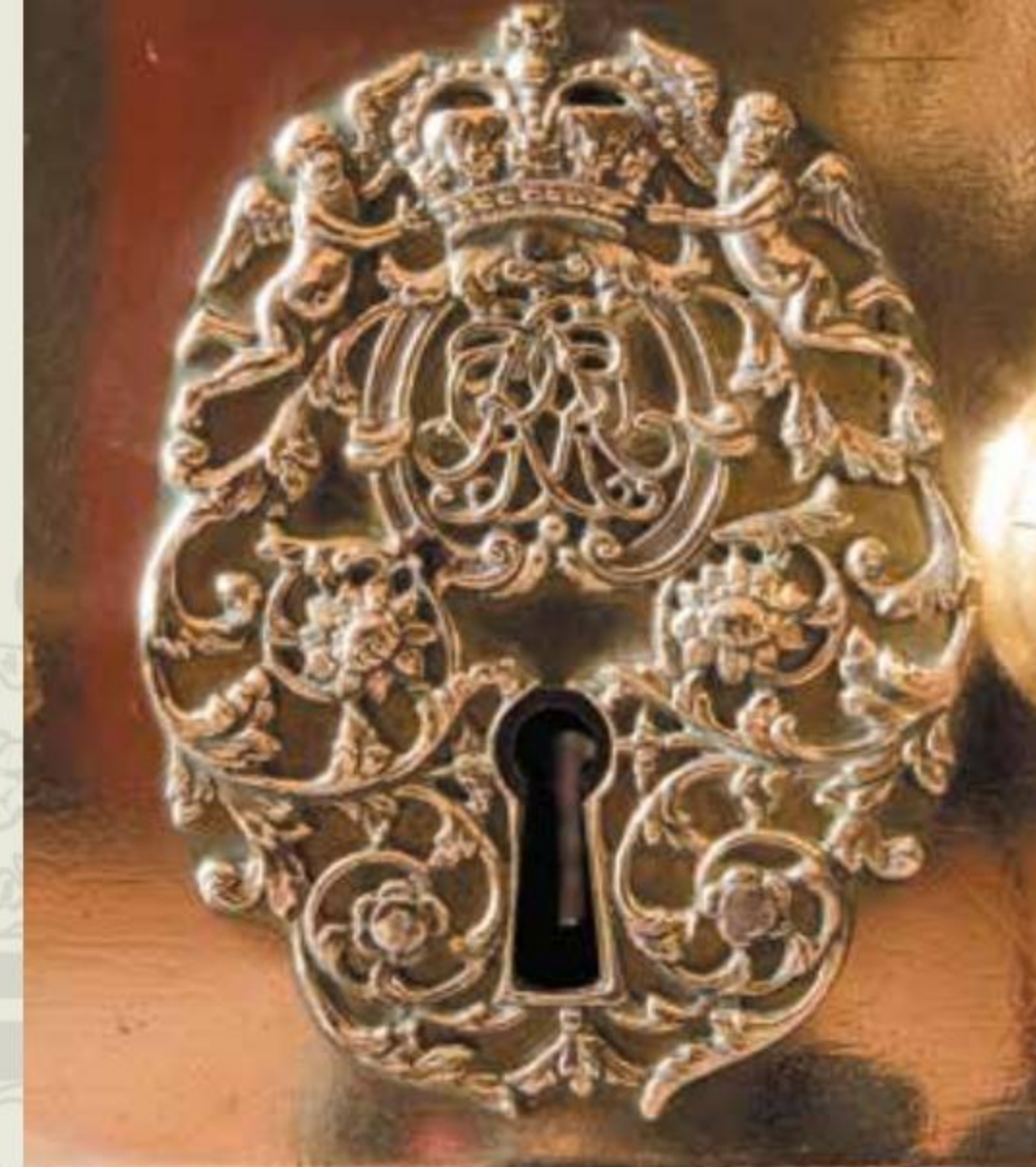

AVAILABLE IN THREE UNIQUE FINISHES



Aged Brass



Heritage Bronze



Natural Brass

“Each solid brass finish has been meticulously matched to those found in the royal palaces. Handcrafted to bring a sense of grandeur and refinement, it is a privilege to share this journey of artistry and tradition with you.”

LEE LOVETT, CO-FOUNDER & CREATIVE DIRECTOR

Bespoke options

THE SOHO LIGHTING CO.

Offering you the opportunity to create truly one-of-a-kind sockets and switches for your interior.





**6 GANG 2-WAY TOGGLE SWITCH
WITH CLASSIC TOGGLES**

Shown in: The Palaces Collection,
Aged Brass
From: £219

INTRODUCING
Soho Lighting's
BESPOKE ENGRAVING
SERVICE



Personalise your space

Many of us experience the process of guessing which switch controls which set of lights. Our bespoke engraving service removes this frustration, enabling a clear and simple lighting navigation.

Our customisation service includes:

- Custom engravings with a selection of fonts
- Custom pairing of finishes with our extensive choice of toggle and dimming knob designs

We believe by providing these extra layers of customisation, your switches and sockets will truly reflect your unique style and design needs.

Our personal service

THE SOHO LIGHTING CO.

Handcrafting in the UK enables us to adapt our products and services to your unique requirements.



INDUSTRY EXPERTS

Our integrated approach to each project

When you choose Soho Lighting, you are gaining the expertise of our team of professional electricians who, alongside our customer service team, aim to deliver your project with care, efficiency and expertise. We offer expert technical advice on switches & sockets, wiring design, extractions from plan and lighting design scoping calls; with each project overseen by a dedicated account manager. From an initial call, through to project scoping, sample room creation, to site visits, and on-time delivery, we are on hand for the duration of your project.



For more information about this service, please contact our customer service team on 0208 106 1221 or by email at info@soholighting.com



Independent Lighting Plan Consultancy

Introducing one of our valued independent lighting consultants
Claire Pendarves

We offer the opportunity to engage with an independent lighting consultant. Claire Pendarves originally trained and worked as an interior designer in London before changing course to specialise in lighting. For more information about this service, please contact our customer service team.

" It was whilst working on an interior design project in Switzerland that a renowned lighting consultant was commissioned to carry out the lighting design. I realised that no matter what attention is paid to furniture, fabrics, flooring and window treatments it's the lighting predominantly that can totally transform a space. It can change a mundane interior into something spectacular. It can accentuate good features and help to detract from the negative. *"* And it can make your life easier and more harmonious. *"*



Residential Case Study

Clay Point

“I don’t think my husband and I would have ended up with what we’ve got, in terms of lighting, switches and sockets, if we hadn’t had a team working with us like Soho Lighting. They came up with so many ideas. We couldn’t have worked with a better company.”

Kate and Malcolm Roberts

This stunning coastal, residential project involved an extensive renovation, transforming the period property into a contemporary family home. Using our independent lighting plan service, we provided the client with a comprehensive lighting, switch and socket scheme.





Commercial Case Study

Hilton Hotel

The Hilton Metropole is the second largest hotel in London. We were delighted to be selected to provide the switches and sockets for this extensive hotel renovation. Our Connaught Collection in Black Nickel provided a sleek finish in the hotel bedrooms and our Charterhouse Collection in antique brass delivered a sophisticated and classic aesthetic for the bathrooms. Our ability to scale our service for large commercial projects is a quality for which we have become renowned, and we are honoured to extend our relationship with new Hilton hotels year on year.

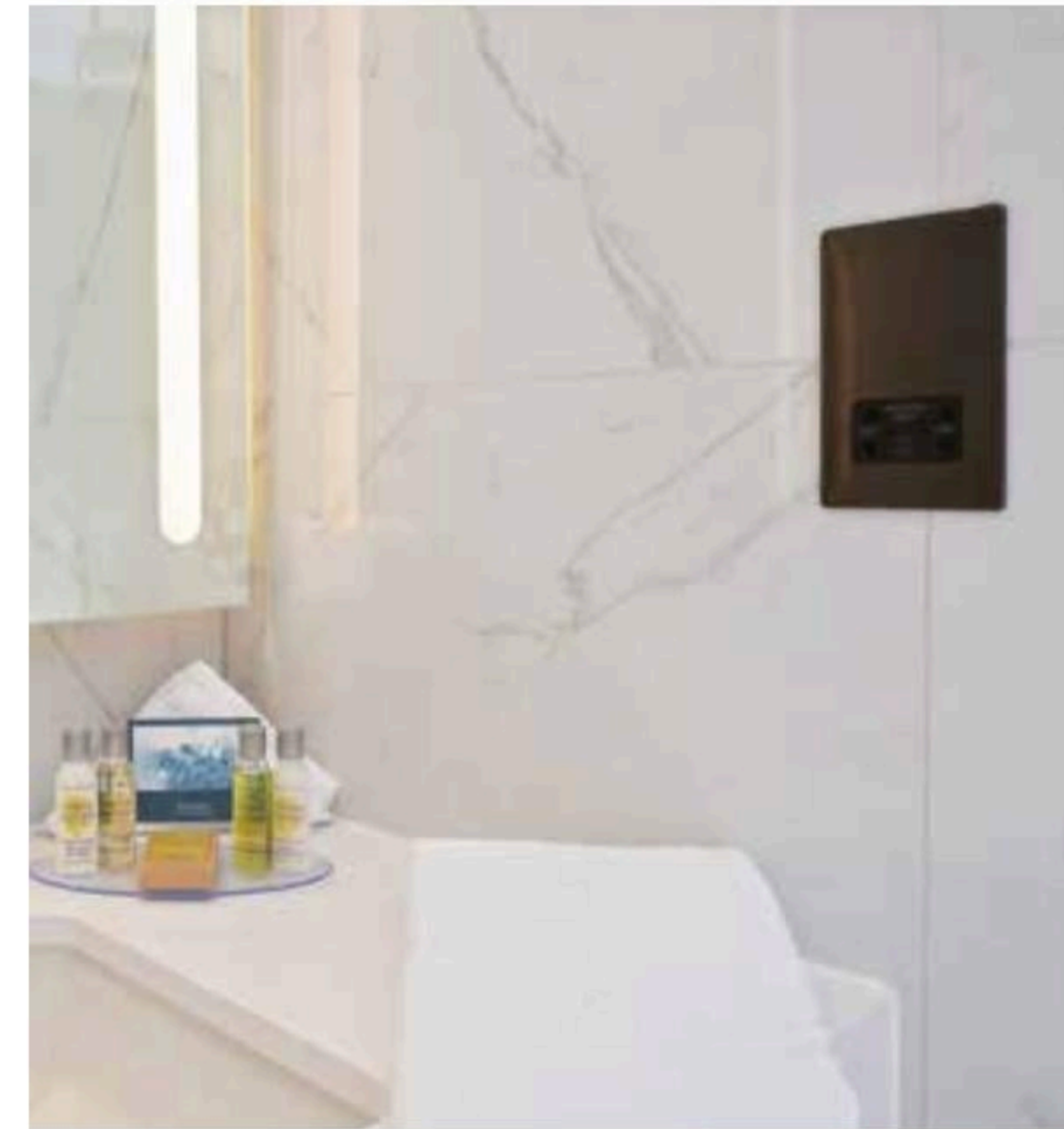

Our collections

THE SOHO LIGHTING CO.

Beautifully designed, meticulously engineered and available in an array of classic and contemporary finishes.



AN INTRODUCTION TO Our plate styles

At The Soho Lighting Company, we understand that every detail matters which is why we offer a variety of plate styles to cater to your unique preferences and interior design needs.

SECTIONS 1&2

Traditional Plate:

TIMELESS ELEGANCE

Our traditional plates are available in a stunning array of 12 finishes. These hand-crafted front plates exude an understated elegance and feature subtle rounded edges and a unique invisible fixing system for a screwless finish.

Flat Plate:

MODERN SIMPLICITY

For those who prefer a contemporary aesthetic, our minimalist flat plate design is the ideal choice. The sleek front plate embodies style and simplicity, making it ideal for contemporary interiors.

SECTION 3

Historic Royal Palaces: The Palaces Collection

LUXURY & REFINEMENT

Handcrafted from solid brass and sitting flush to the wall, these elegant plates are traditional in style but backed by cutting-edge functionality, offering a lifetime of interchangeable potential. Our state-of-the-art MagnaTec™ system will dramatically simplify installation whilst creating a flawless and screwless finish.



Traditional Plate

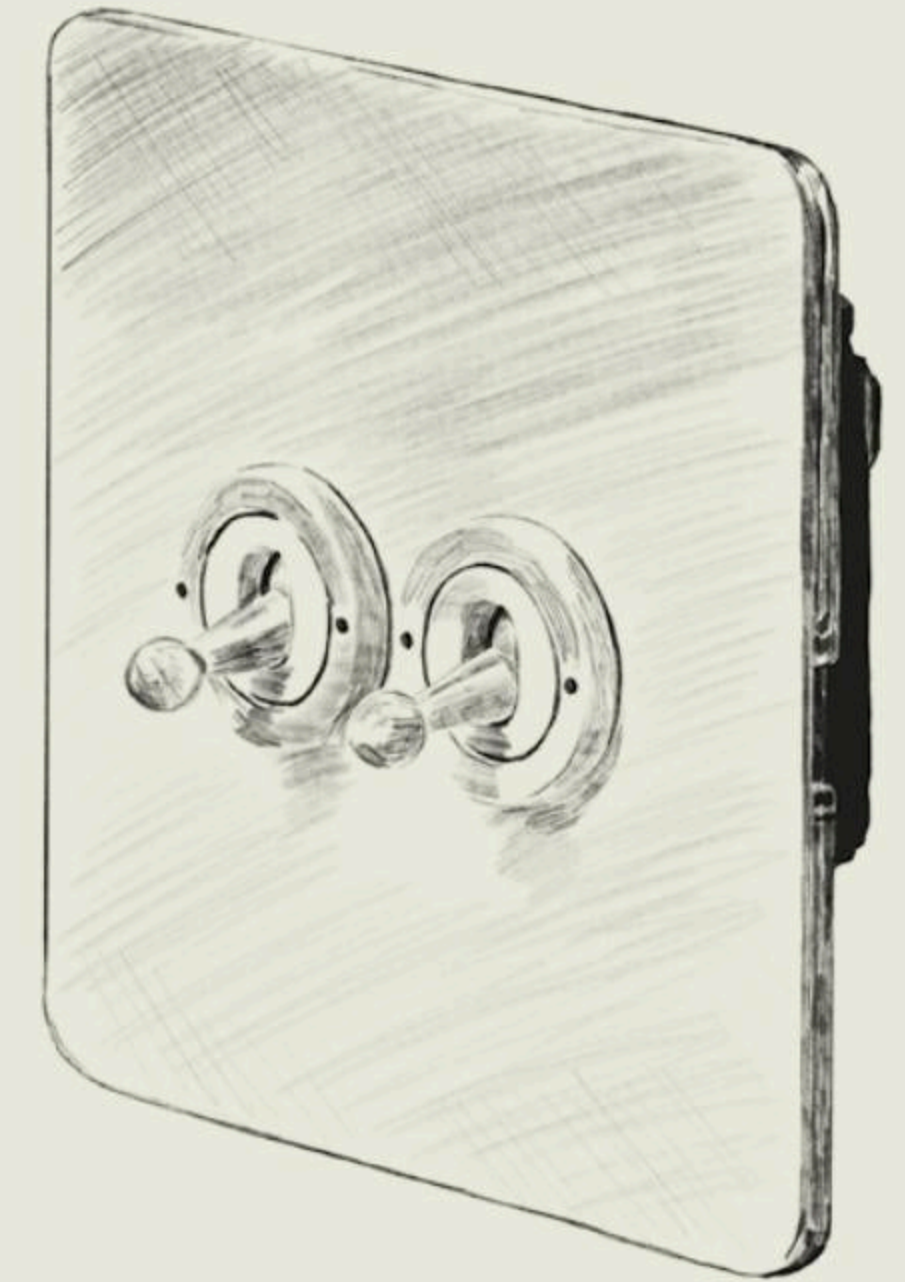

Flat Plate

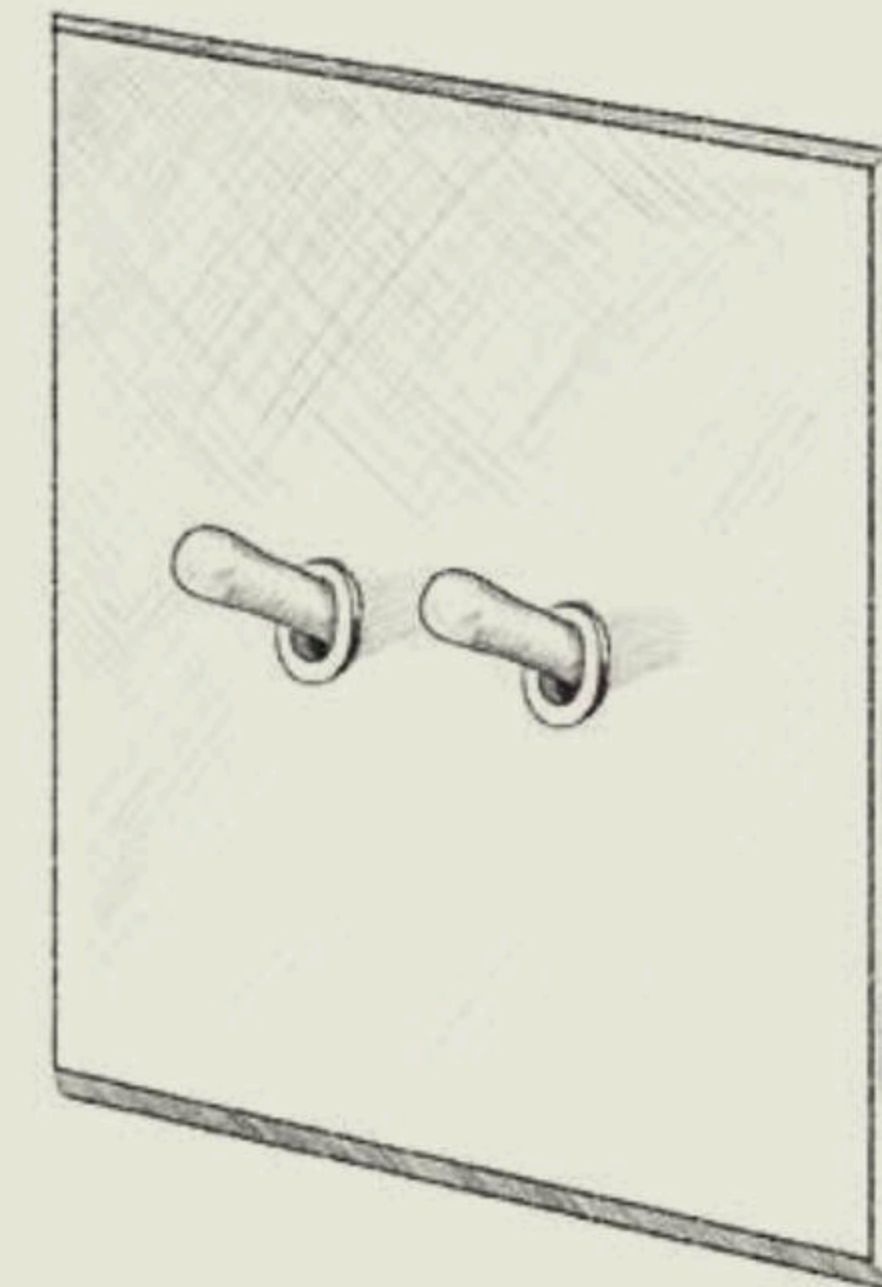

Historic Royal Palaces : The Palaces Collection

AN INTRODUCTION TO
**Our decorative
 switch options**



The Palaces Collection

TRADITIONAL AND FLAT PLATE COLLECTIONS

Three timeless rotary and toggle designs.

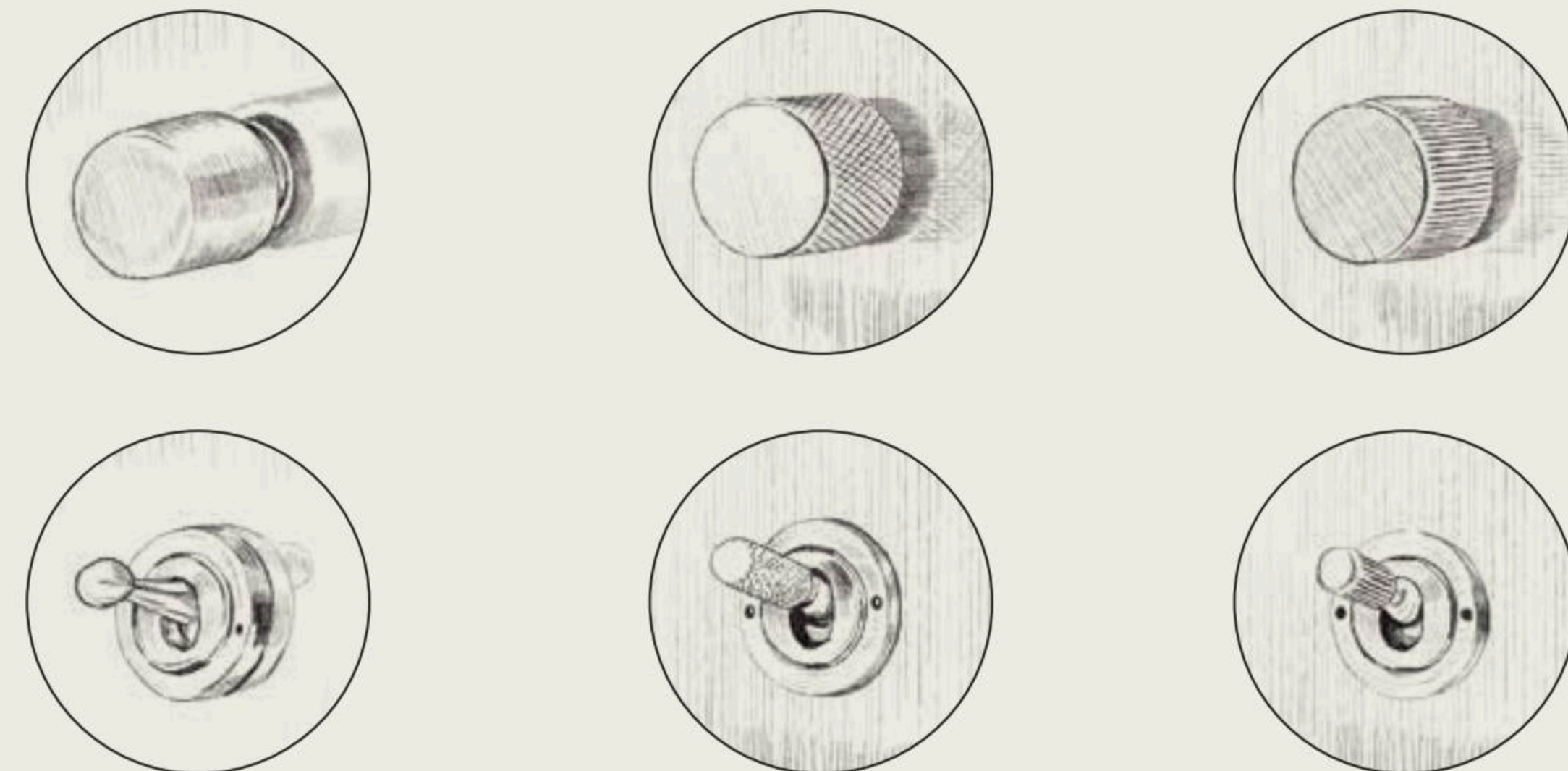

Classic

Vintage Knurled

Art Deco

Sleek and timeless, our classic toggle dimmer design is available as both a tactile toggle switch and a traditional rotary, allowing you to click or turn to dim with precision and style.

For those drawn to a vintage aesthetic, our vintage knurled toggle and rotary design features a beautifully textured switch and rotary dial, delivering tactile elegance and a sense of crafted authenticity in every interaction.

With its clean geometric lines and refined symmetry, this toggle and rotary design channels the elegance and glamour of classic Art Deco style.

Discover more on p. 33

TRADITIONAL AND FLAT PLATE COLLECTIONS

Each precious moment spent behind the scenes of the palaces has been poured into this collection to capture the beauty of the palaces in every handcrafted detail. The three toggle designs are inspired by distinctive and captivating features discovered within these historic homes and are available in Brass and soon-to-launch Heritage Bronze.

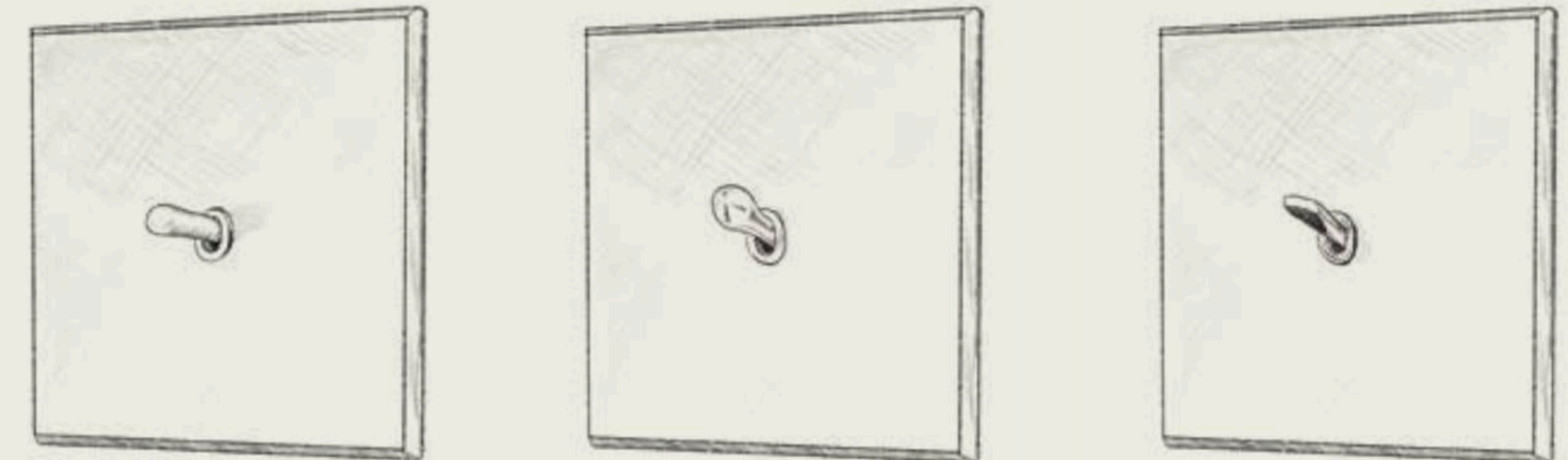

Classic

Ball

Paddle

The Classic Toggle echoes the pared-back luxury of The Palaces Collection plates, offering clean lines, subtle detailing and a discreet, sophisticated style.

A sculptural orb-like toggle, the Ball Toggle's tactile shape gives this hardware purpose, offering a satisfying, intuitive interaction that blends form, function and timeless appeal.

For those who prefer a more contemporary style, the Paddle offers the same intuitive dimming switch experience as our Classic Toggle, but with a flat, streamlined form.

Discover more on p. 61



SECTIONS 1&2

Traditional & Flat Plates

Our traditional plates are available in a stunning array of 12 finishes. These hand-crafted front plates exude an understated elegance, feature subtle rounded edges and a unique invisible fixing system for a screwless finish.

TRADITIONAL PLATES

The Charterhouse Collection

● ANTIQUE BRASS

The Charterhouse Collection of lacquered antique brass sockets and switches offers a timeless appearance, providing a warm tone which naturally conceals fingerprints and small blemishes.

1 GANG SOCKET

Code: SKT101
From: £20

13A TOGGLE SWITCHED FUSE

Code: ISO320
From: £45



Explore *infinite* possibilities

This antique brass finish is available in over 130 switch and socket variations.

Go to [P.76](#) →

2 GANG 2-WAY LIGHT SWITCH

Code: LTS102
From: £23



Wall colour: Jonquil by Edward Bulmer Natural Paint

2 GANG TOGGLE SWITCH 2-WAY

Code: LTS302
From: £53

Charterhouse Finish code:
ABB (Antique Brass with Black Inserts)

TRADITIONAL PLATES The Savoy Collection

● BRUSHED BRASS

The refined Savoy Collection of brushed brass sockets and switches enrich a space with warm, golden brass tones. Paired with a choice of black or white inserts, this versatile collection creates impact in any interior setting.

1 GANG USB C+C 13A SOCKET
Code: SKT221
From: £37

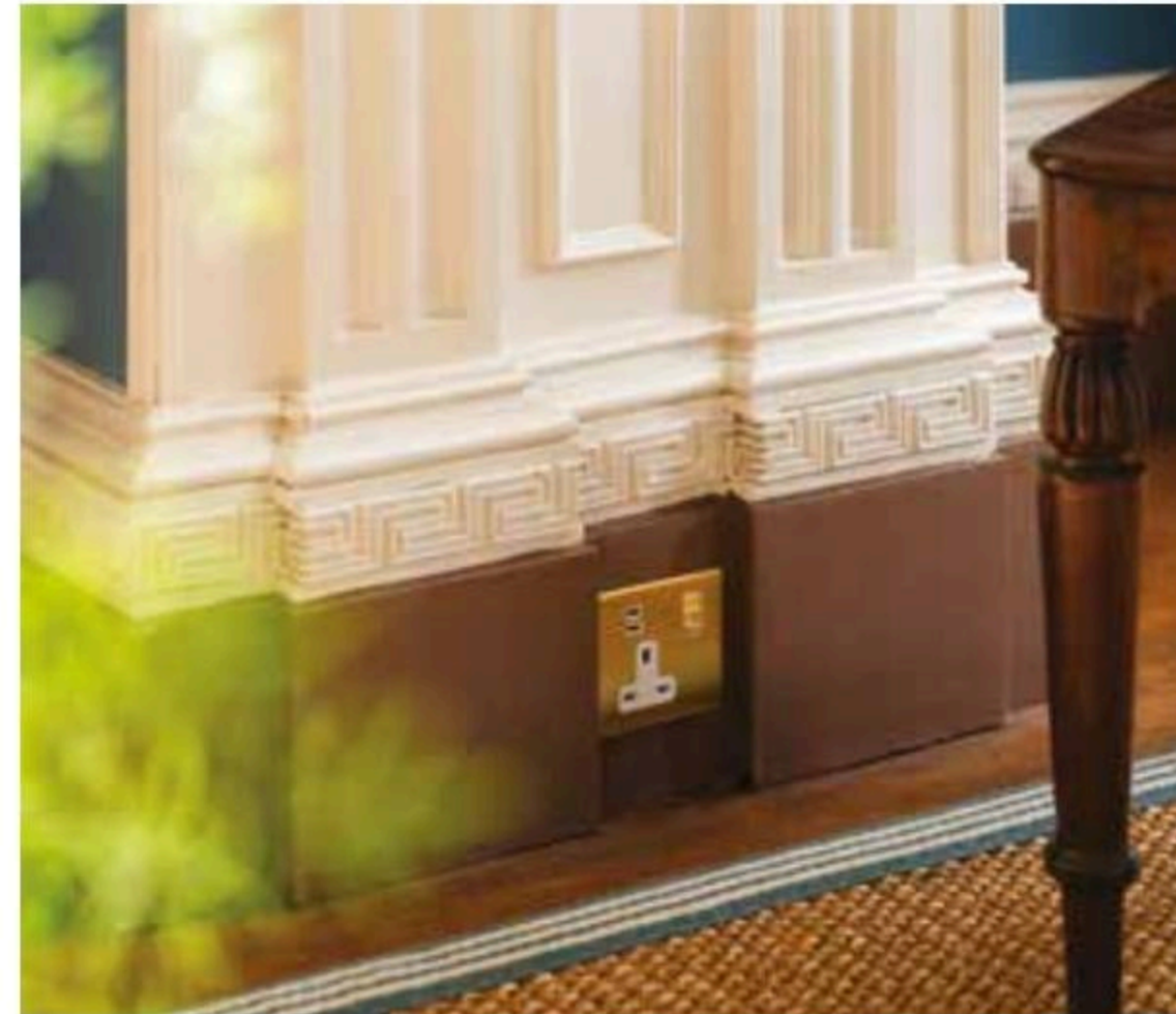

Explore *infinite* possibilities

This brushed brass finish is available in over 130 switch and socket variations.

Go to **P.76** →

2 GANG DIMMER AND TOGGLE SWITCH COMBO
Code: LTS341
From: £60

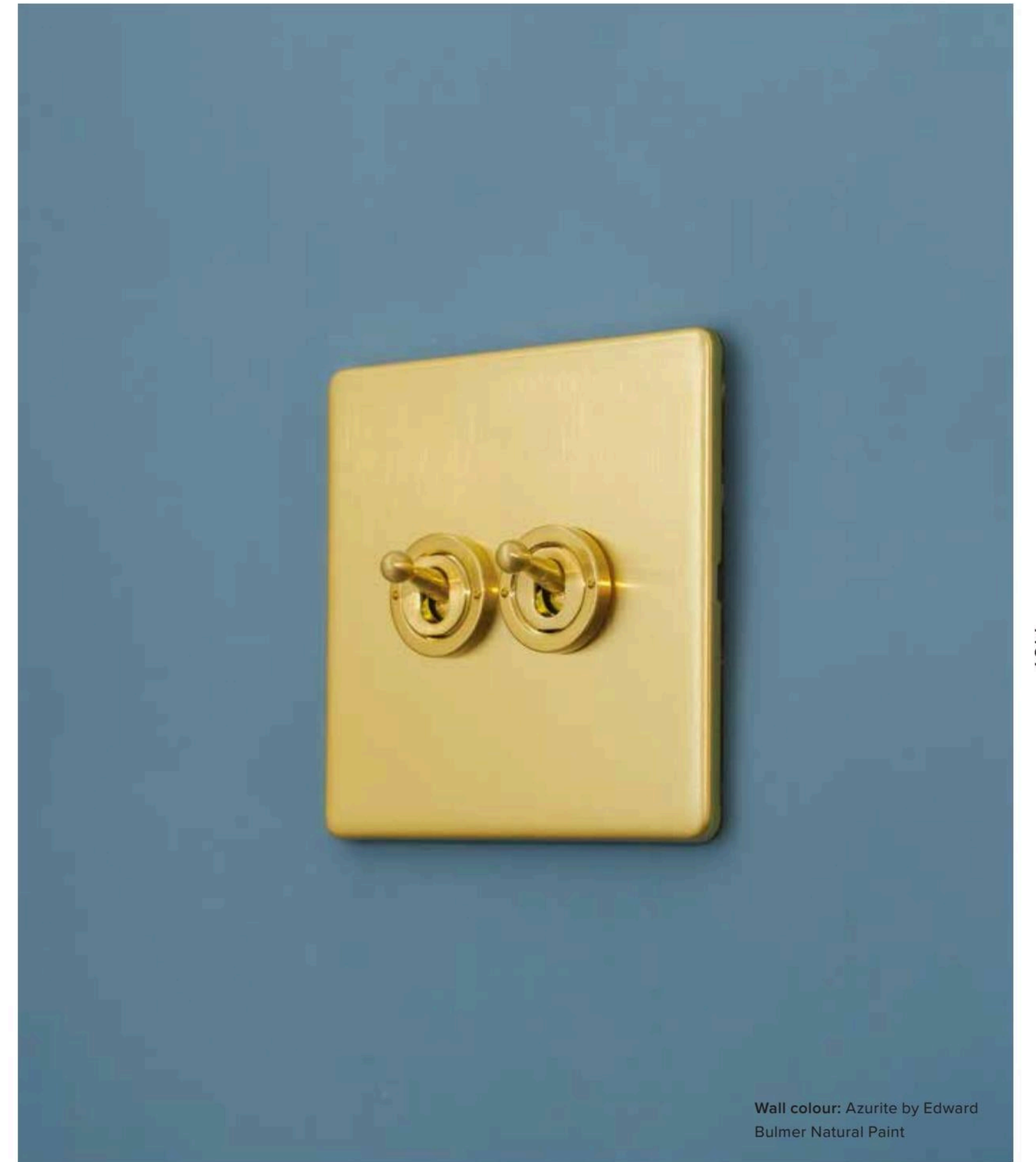

Wall colour: Azurite by Edward Bulmer Natural Paint

2 GANG TOGGLE SWITCH 2-WAY
Code: LTS302
From: £53

Savoy Finish codes:
BBB (Brushed Brass & Black Inserts)
BBW (Brushed Brass & White Inserts)

TRADITIONAL PLATES

The Westminster Collection

● VINTAGE BRASS

Our Westminster Collection of plates have been carefully matched to original Georgian and Victorian brass works such as door handles and cabinetry details, giving a faithful representation of heavily oxidised, un-polished, timeworn brass, with a rich dark matt patina. These traditional switches and sockets will add authenticity to period properties adding layers of interest to an interior.

2 GANG USB A+C SOCKET
Code: SKT204
From: £53

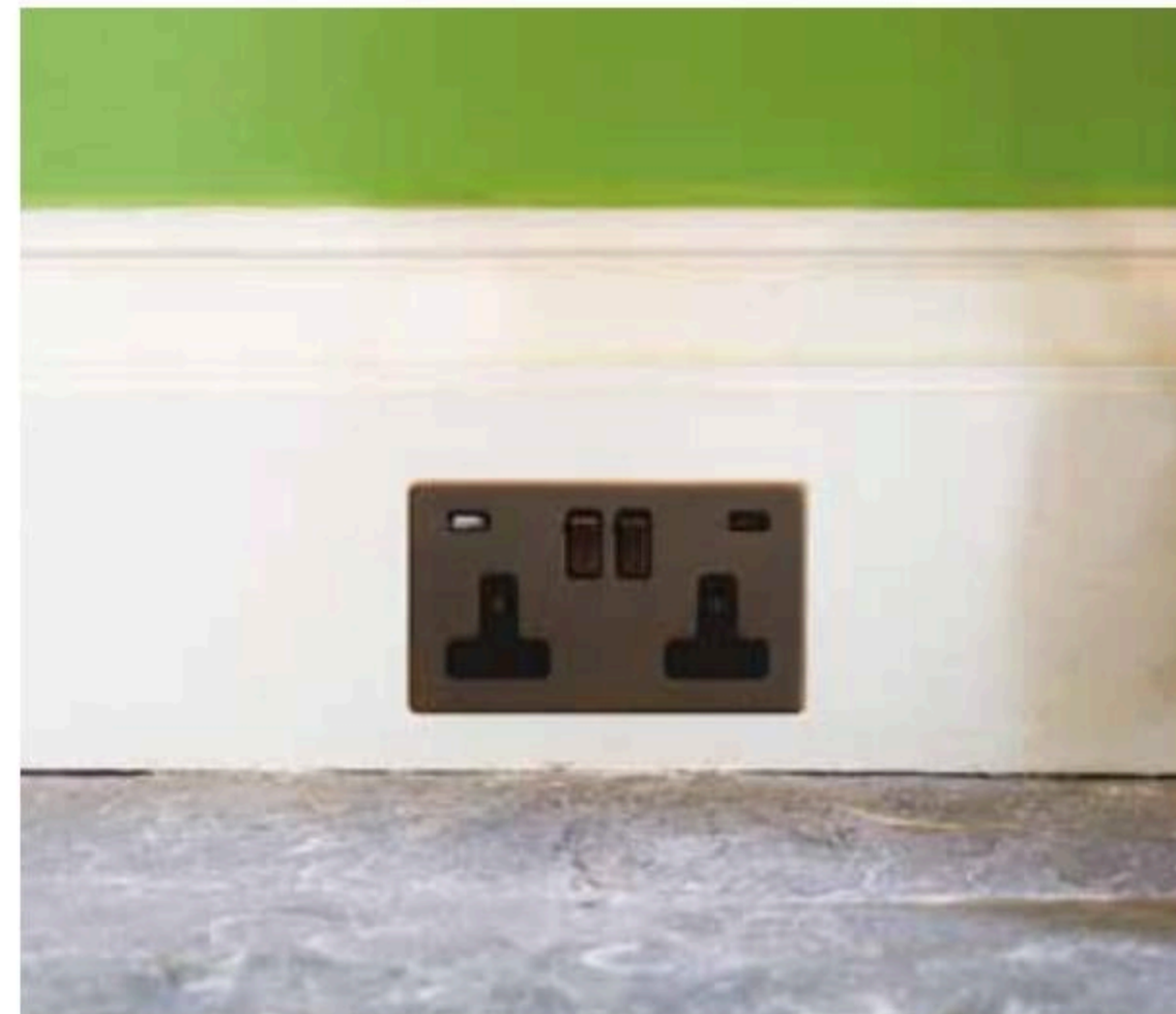

Explore *infinite* possibilities

This vintage brass finish is available in over 130 switch and socket variations.

Go to [P.76](#) →

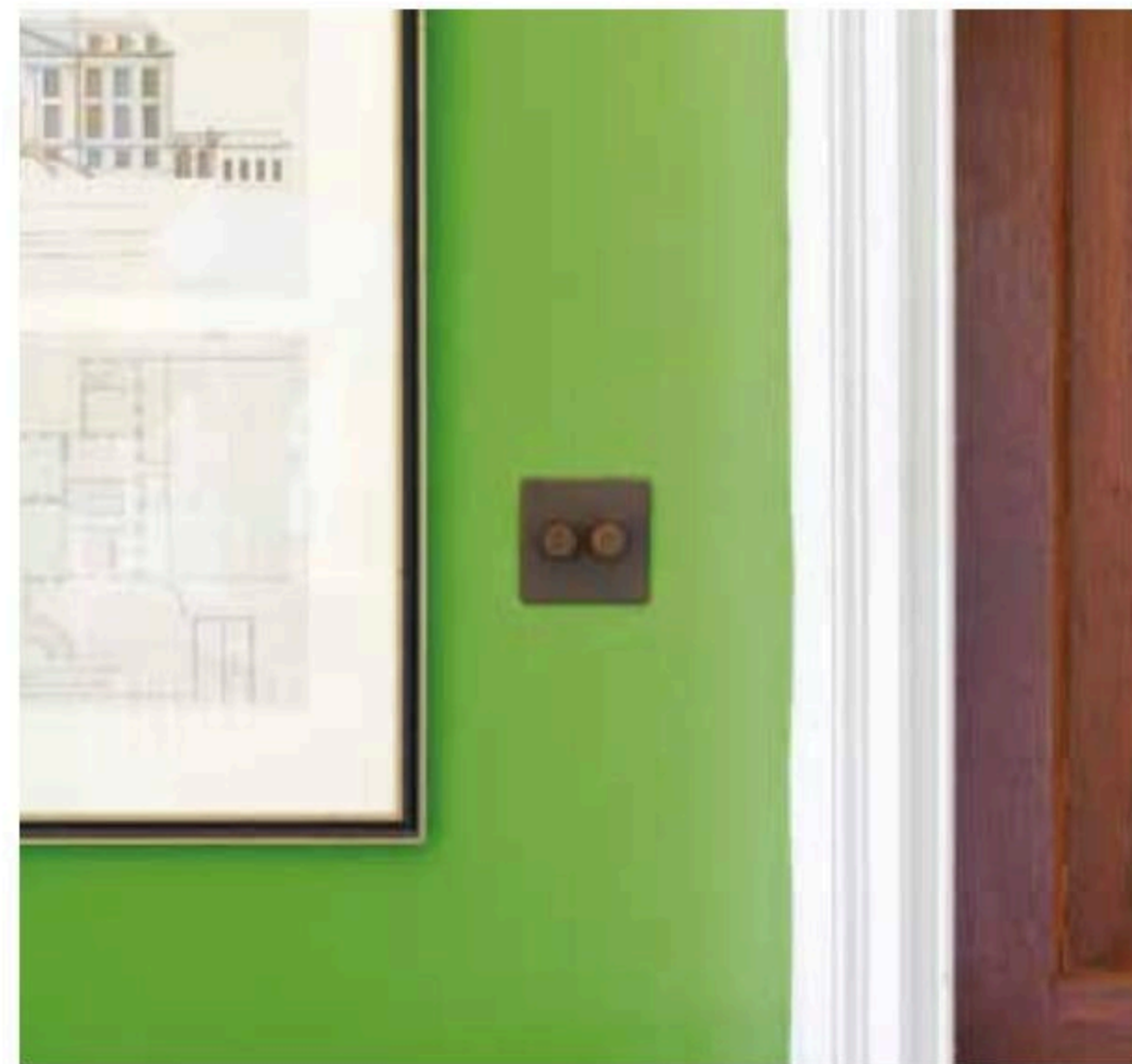

2 GANG 2 WAY INTELLIGENT DIMMER

Code: LTS202
From: £81

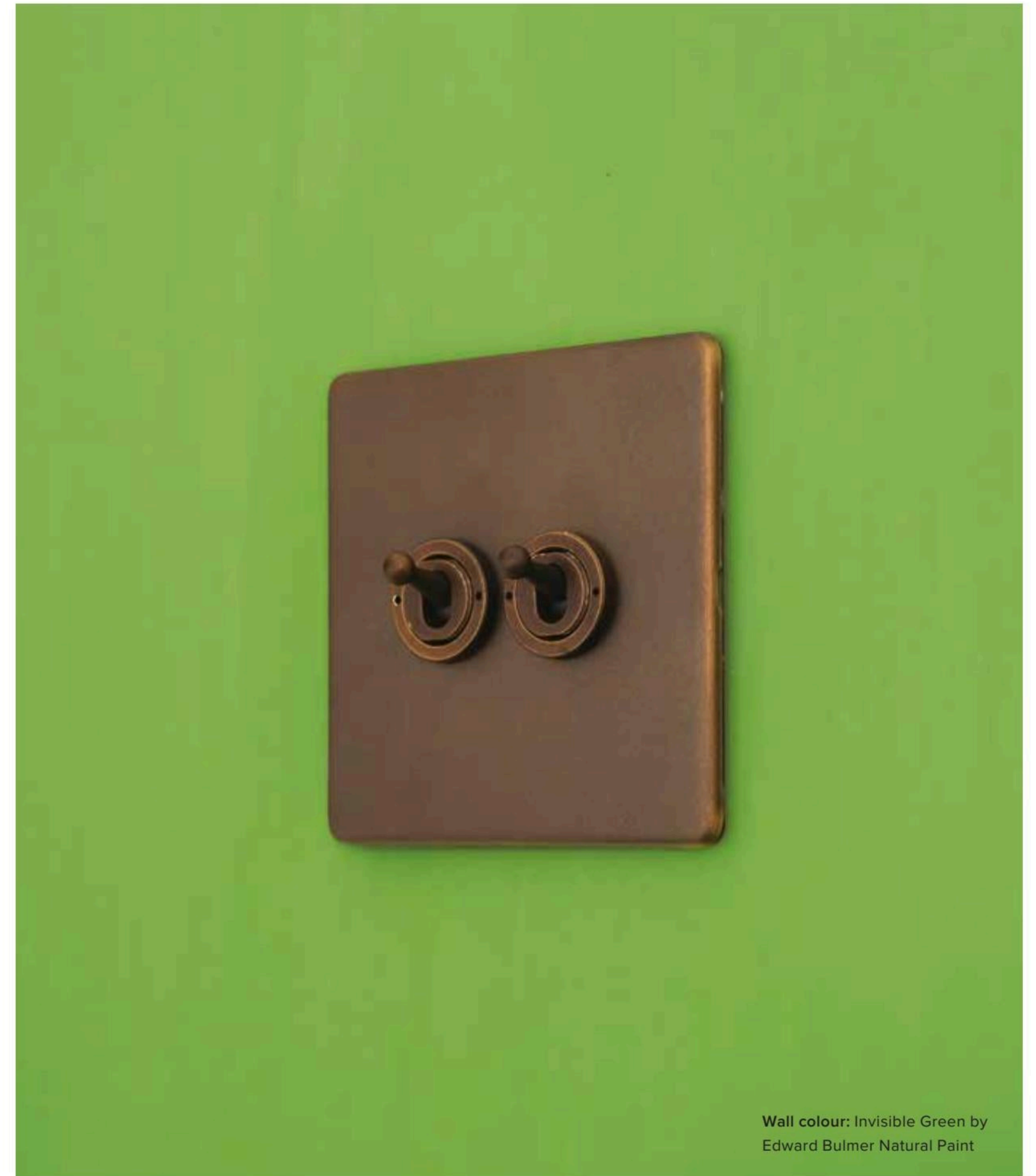

2 GANG TOGGLE SWITCH 2-WAY

Code: LTS302
From: £60

Wall colour: Invisible Green by Edward Bulmer Natural Paint

Westminster Finish code:
VBB (Vintage Brass & Black Inserts)

TRADITIONAL PLATES The Belgravia Collection

● OLD BRASS

Our Belgravia Collection of plates have been carefully matched to original pieces of Georgian brass work, such as door handles and cabinetry details, giving a faithful representation of oxidised, un-polished, timeworn brass, with a rich honey matt patina. These traditional switches and sockets will add authenticity to period properties while also working well in contemporary settings to add layers of interest to a space.

2 GANG DOUBLE POLE SOCKET 13A

Code: SKT102
From: £33.97

13A DOUBLE POLE SWITCHED FUSE CONNECTION UNIT

Code: ISO133
From: £37



Explore *infinite* possibilities

This old brass finish is available in over 130 switch and socket variations.

Go to **P.76** →

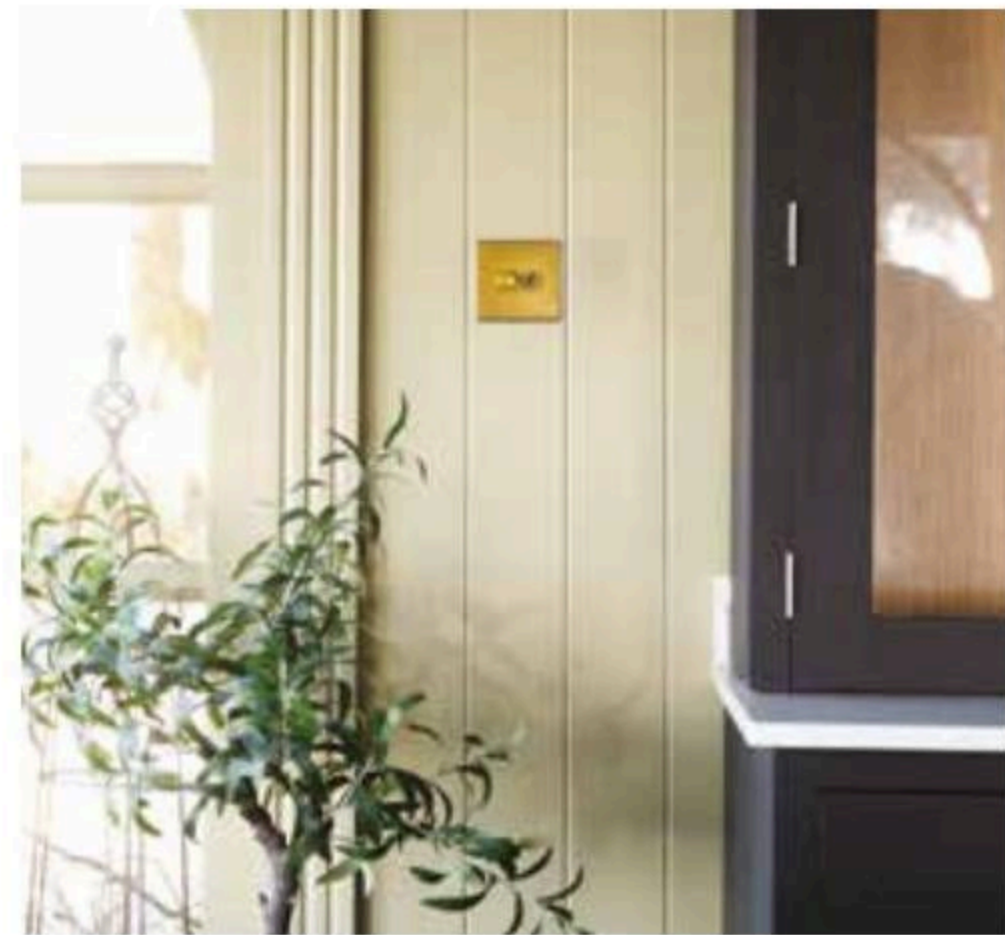

2 GANG DIMMER AND TOGGLE SWITCH COMBO

Code: LTS341
From: £66



Wall colour: Drab Green by Edward Bulmer Natural Paint

2 GANG TOGGLE SWITCH 2-WAY

Code: LTS302
From: £60

Belgravia Finish code:
OB (Old Brass & Black Inserts)

TRADITIONAL PLATES The Eton Collection

- BRONZE
- BRONZE WITH BRUSHED BRASS INSERTS

The sumptuously rich, dark qualities of this matt bronze finish is undeniably classic and looks resplendent in period style interiors. The subtle sheen of the switch toggle and rockers authentically replicates years of use, offered in a choice of two accent detail pairings: subtle antiqued bronze or brushed brass.

Go to P.76 →

1 GANG TOGGLE SWITCH

Code: LTS301
From: £31.97

2 GANG TOGGLE SWITCH

Code: LTS302
From: £56

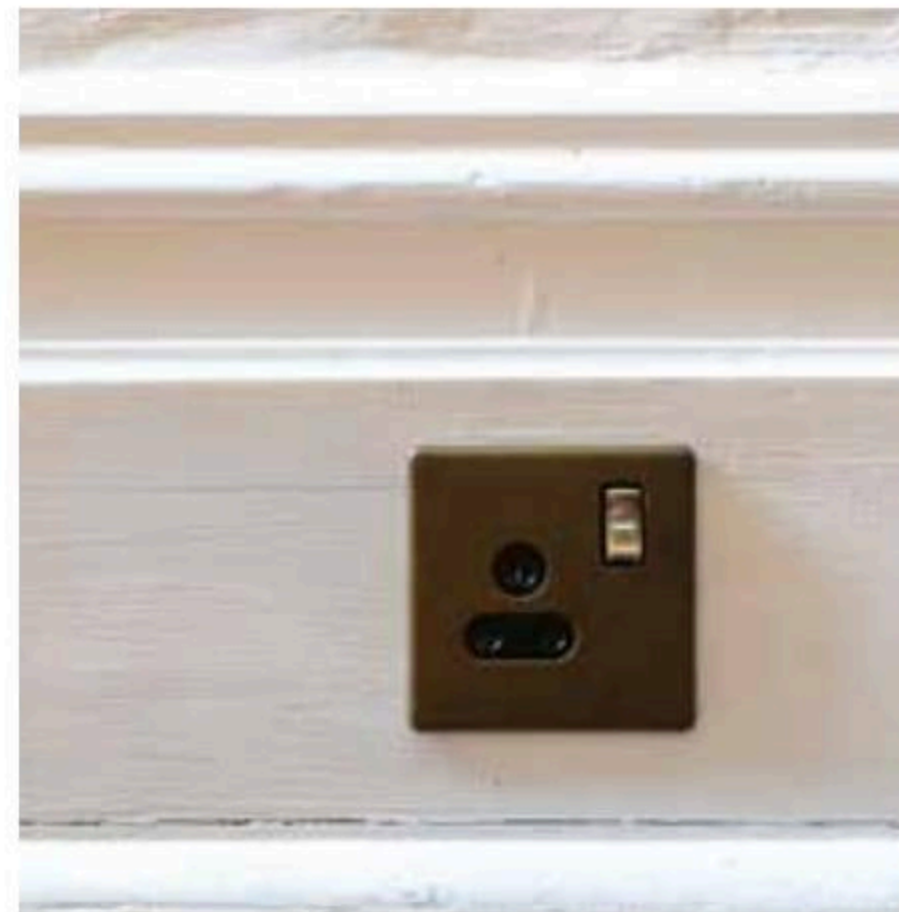

5 AMP SWITCHED SOCKET

Code: SKT302
From: £28

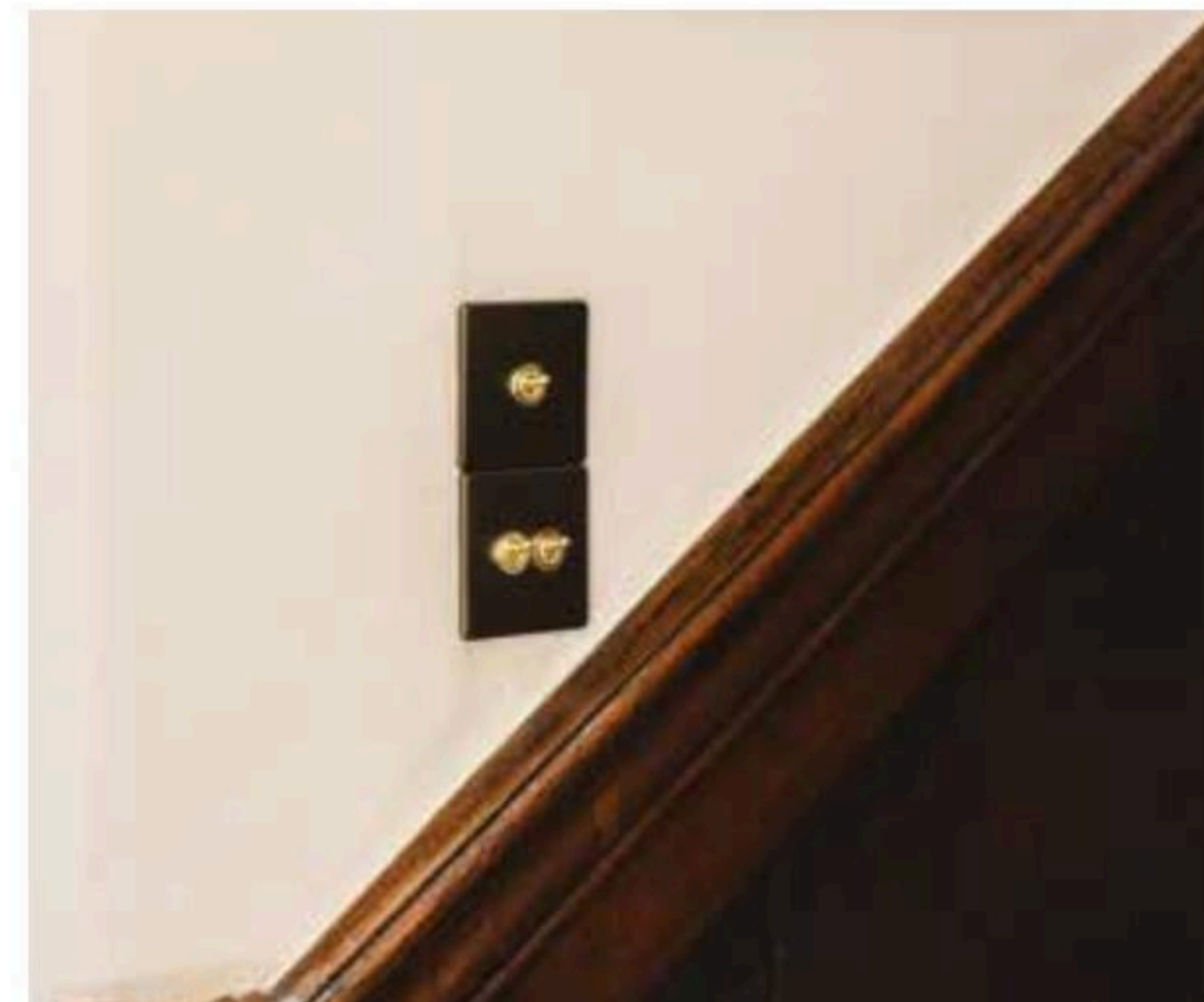

Explore *infinite* possibilities

This bronze finish is available in over 130 switch and socket variations.

Go to P.76 →



Wall colour: Lilac Pink by Edward Bulmer Natural Paint

2 GANG TOGGLE SWITCH 2-WAY

Code: LTS302
From: £56

Eton Finish codes:
BZB (Bronze & Black Inserts)
BZR (Bronze & Brushed Brass Inserts)

TRADITIONAL PLATES The Sloane Collection

● ANTIQUE GOLD

Our Sloane Collection of plates exudes luxury and elegance. This lustrous reflective finish will catch the light beautifully, complementing both period and contemporary interiors, providing a striking accent in any room.

2 GANG 2 WAY SWITCH

Code: LTS102
From: £23

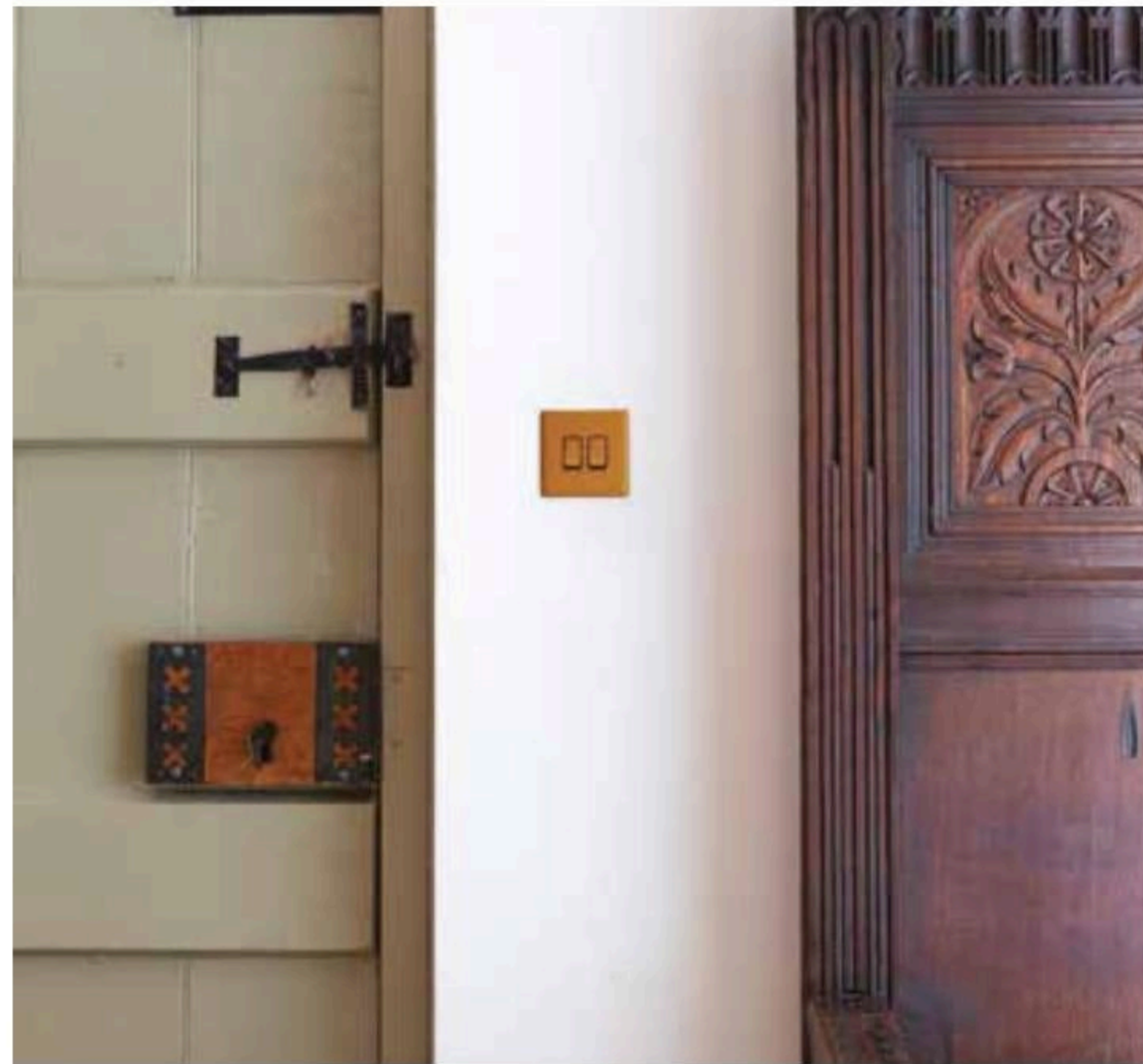

2 GANG DOUBLE POLE SOCKET 13A

Code: SKT102
From: £18.97

Explore *infinite*
possibilities

This black nickel finish is available in over 130 switch and socket variations.

Go to **P.76** →



Wall colour: Pearl Colour by Edward Bulmer Natural Paint

2 GANG TOGGLE SWITCH 2-WAY

Code: LTS302
From: £53

Sloane Finish code:
AGB (Antique Gold & Black Inserts)

TRADITIONAL PLATES The Chiswick Collection

● ANTIQUE COPPER

The exquisite copper plates of the Chiswick Collection are hand finished and individually aged to perfection, giving each plate a natural, warm and classic appeal.

DIMMER AND ROCKER SWITCH COMBO

Code: LTS132
From: £58



Explore *infinite* possibilities

This antique copper finish is available in over 130 switch and socket variations.

Go to **P.76** →



2 GANG DOUBLE POLE SOCKET 13A

Code: SKT102
From: £24.97

1 GANG TV AERIAL AND SATELITE SOCKET

Code: MED101
From: £28



Wall colour: Verdigris by Edward Bulmer Natural Paint

2 GANG TOGGLE SWITCH 2-WAY

Code: LTS302
From: £60

Chiswick Finish code:
ACB (Antique Copper & Black Inserts)

TRADITIONAL PLATES

The Camden Collection

- MATT BLACK
- MATT BLACK WITH BRUSHED BRASS INSERTS
- MATT BLACK WITH ANTIQUE BRASS INSERTS

The commanding appearance and flawless softened matt finish of this range strikes a masculine tone and is a popular choice for contemporary homes. Available with matt black, antique brass or brushed brass toggles and dimmer detailing to perfectly complement your interior.

2 GANG 2-WAY PUSH BUTTON SWITCH

Code: LTS602
From: £39

Explore *infinite* possibilities

This matt black finish is available in over 130 switch and socket variations.

Go to **P.76** →



Wall colour: Lilac Pink by Edward Bulmer Natural Paint

2 GANG TOGGLE SWITCH 2-WAY

Code: LTS302
From: £56

Camden Finish codes:
MBB (Matt Black & Black Inserts)
MBR (Matt Black & Brushed Brass Inserts)
MBT (Matt Black & Antique Brass Inserts)

TRADITIONAL PLATES

The Lombard Collection

● BRUSHED CHROME ● BRUSHED CHROME WITH BRUSHED BRASS INSERTS

The Lombard Collection of brushed chrome sockets and switches offers a subtle silvered finish with a durable texture that has the added practical benefit of hiding fingerprints and small blemishes. Available with a choice of brushed chrome or brushed brass accent detailing.

THE SOHO LIGHTING CO.

10A 2 GANG 2 WAY SWITCH

Code: LTS102
From: £26

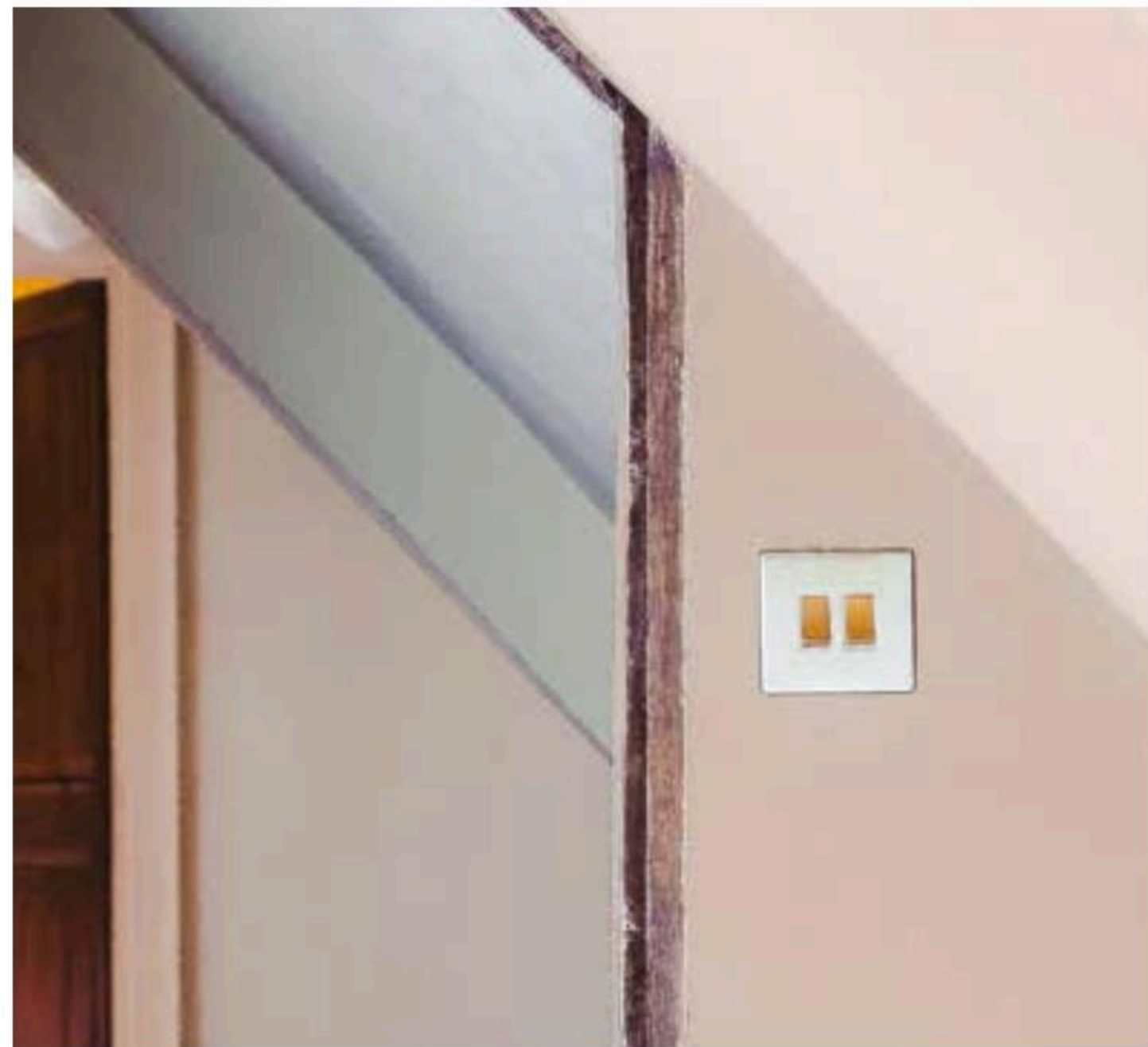

1 GANG DP SOCKET

Code: SKT101
From: £19

13A DOUBLE POLE SWITCHED FUSE CONNECTION UNIT

Code: ISO133
From: £31

Explore *infinite* possibilities

This brushed chrome finish is available in over 130 switch and socket variations.

Go to **P.76** →



2 GANG TOGGLE SWITCH 2-WAY

Code: LTS302
From: £53

Wall colour: Jonquil by Edward Bulmer Natural Paint

Lombard Finish codes:
BCB (Brushed Chrome & Black Inserts)
BCS (Brushed Chrome & Brushed Brass Inserts)
BCW (Brushed Chrome & White Inserts)

P. 51

TRADITIONAL PLATES

Finbury Collection

● POLISHED CHROME

The Finsbury Collection of polished chrome sockets and switches will bounce light throughout your interior, with its reflective silvered finish. Available in a choice of black and white inserts.

THE SOHO LIGHTING CO.



**2 GANG 2 WAY PUSH
BUTTON SWITCH**

Code: LTS602
From: £39

Explore *infinite* possibilities

This polished chrome finish is available in over 130 switch and socket variations.

Go to P.76 →



2 GANG USB A+C SOCKET

Code: SKT204
From: £31.99



Wall colour: Drab Green by Edward Bulmer Natural Paint

2 GANG TOGGLE SWITCH 2-WAY

Code: LTS302
From: £53

Finsbury Finish codes:
PCB (Polished Chrome & Black Inserts)
PCW (Polished Chrome & White Inserts)

P. 53

TRADITIONAL PLATES

The Connaught Collection

● BLACK NICKEL

The Connaught Collection of black nickel sockets and switches provide a distinctive mirrored finish giving a luxe appeal to any space.

4 GANG 400W LED DIMMER SWITCH

Code: LTS244
From: £175



Explore *infinite* possibilities

This black nickel finish is available in over 130 switch and socket variations.

Go to **P.76** →

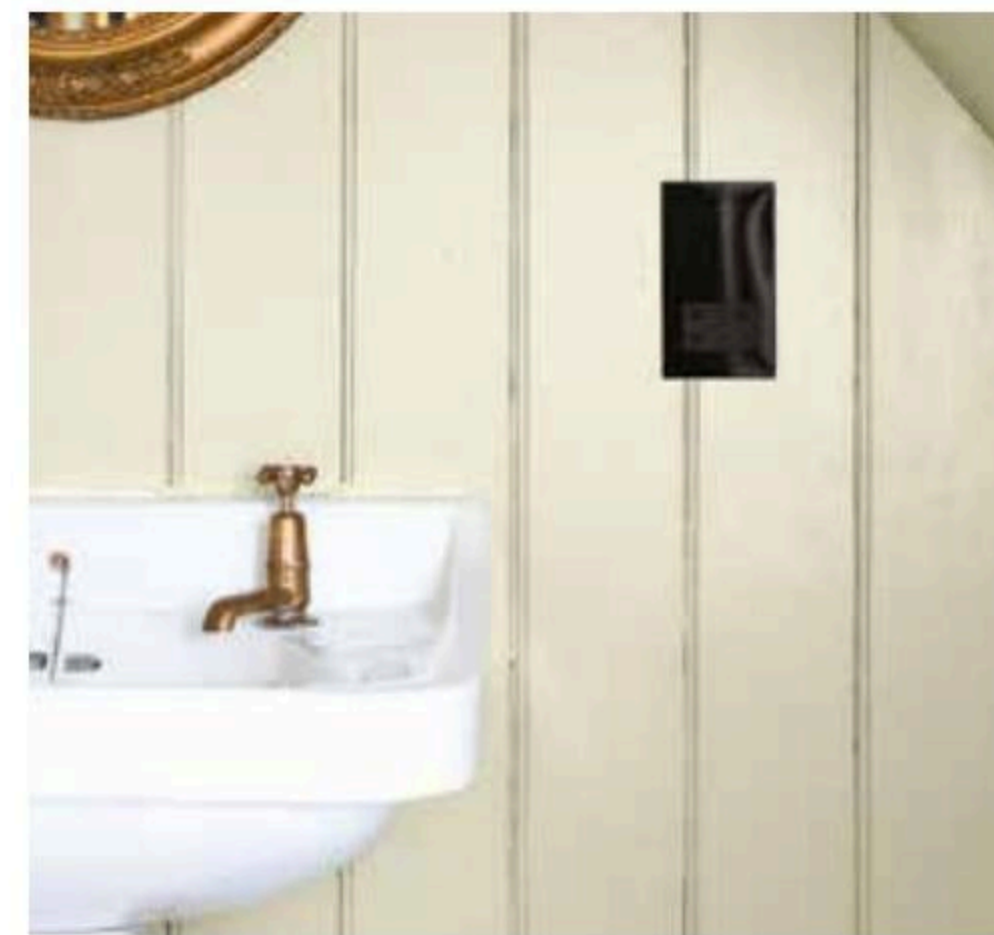

SHAVER SOCKET

Code: SKT401
From: £54

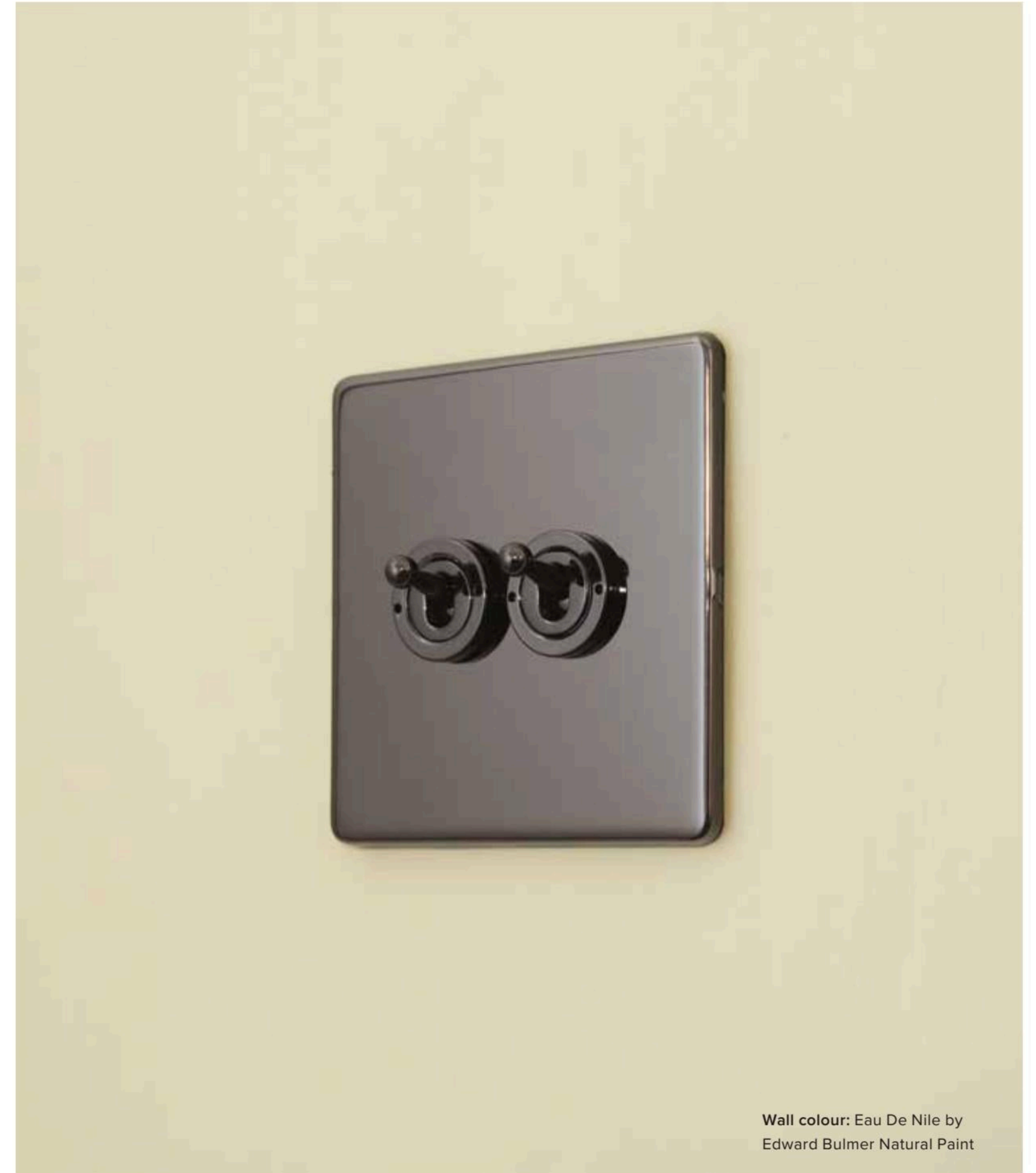

Wall colour: Eau De Nile by Edward Bulmer Natural Paint

2 GANG TOGGLE SWITCH 2-WAY

Code: LTS302
From: £53

Connaught Finish code:
BNB (Black Nickel & Black Inserts)

TRADITIONAL PLATES

The Paintable Collection

For those seeking a cohesive look in a particular room or throughout a scheme or space, our Paintable Collection offers you the opportunity to match your switches and sockets with your preferred wall colour; enabling your plates to seamlessly disappear into your paintwork. Available with several toggle and dimmer finish options, you can achieve this while still benefiting from our celebrated dimmer, toggle and rocker designs and finishes.

Explore *infinite* possibilities

Introducing our prebuilt switch and socket options.

Go to [P.76](#) →

2 GANG 13A SOCKET

Code: SKT102
From: £24.97

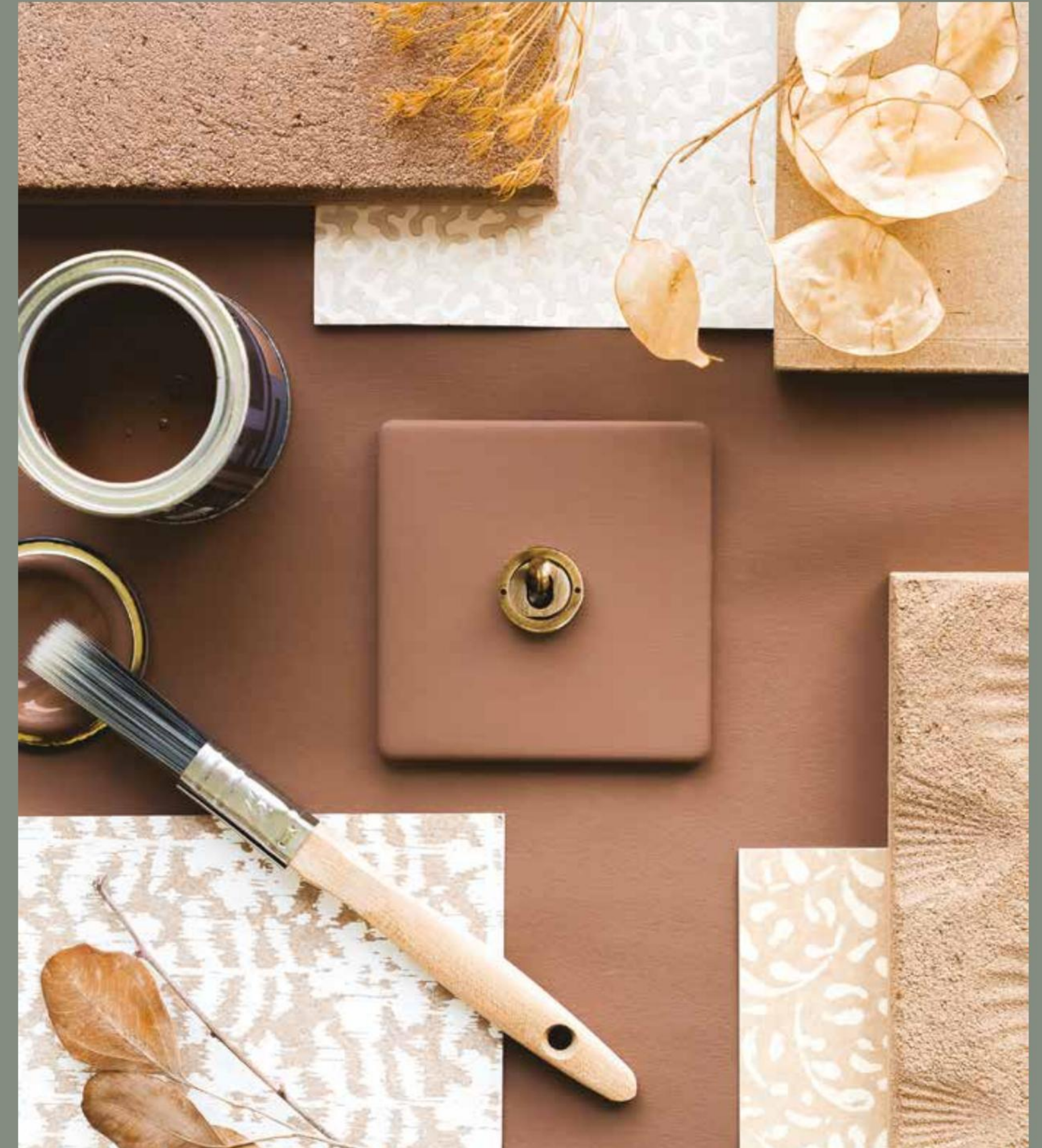

1 GANG TOGGLE LIGHT SWITCH 2 WAY WITH ANTIQUE BRASS SWITCH

Code: LTS301
From: £31.97

Paintable Finish codes:
PMQ (Paintable & White Metal)
PMR (Paintable & Brushed Brass and Black)
PMS (Paintable & Brushed Brass and White)
PMT (Paintable & Antique Brass)
PMY (Paintable & Brushed Chrome and Black)
PMZ (Paintable & Brushed Chrome and White)

Wall colour: Jonquil by Edward
Bulmer Natural Paint

FLAT PLATES

The Eldon Collection

- WHITE METAL
- WHITE METAL WITH CHROME

The Eldon Collection is a popular choice for modern styled homes and works seamlessly in white kitchens and neutral interiors. For those who prefer a contemporary aesthetic, this minimalist flat plate design is the ideal choice. It is available with white or polished chrome accent detailing.

Explore *infinite* possibilities

This white metal finish is available in over 130 switch and socket variations.

Go to P.76 →



3 GANG 2 WAY SWITCH

Code: LTS103
From: £31



2 GANG SOCKET

Code: SKT102
From: £18.97



Wall colour: Dove by Edward Bulmer Natural Paint

2 GANG TOGGLE SWITCH 2-WAY

Code: LTS302
From: £53

Eldon Finish codes:
WPW (White Metal & White Inserts)
WPX3 (White Metal & Polished Chrome)

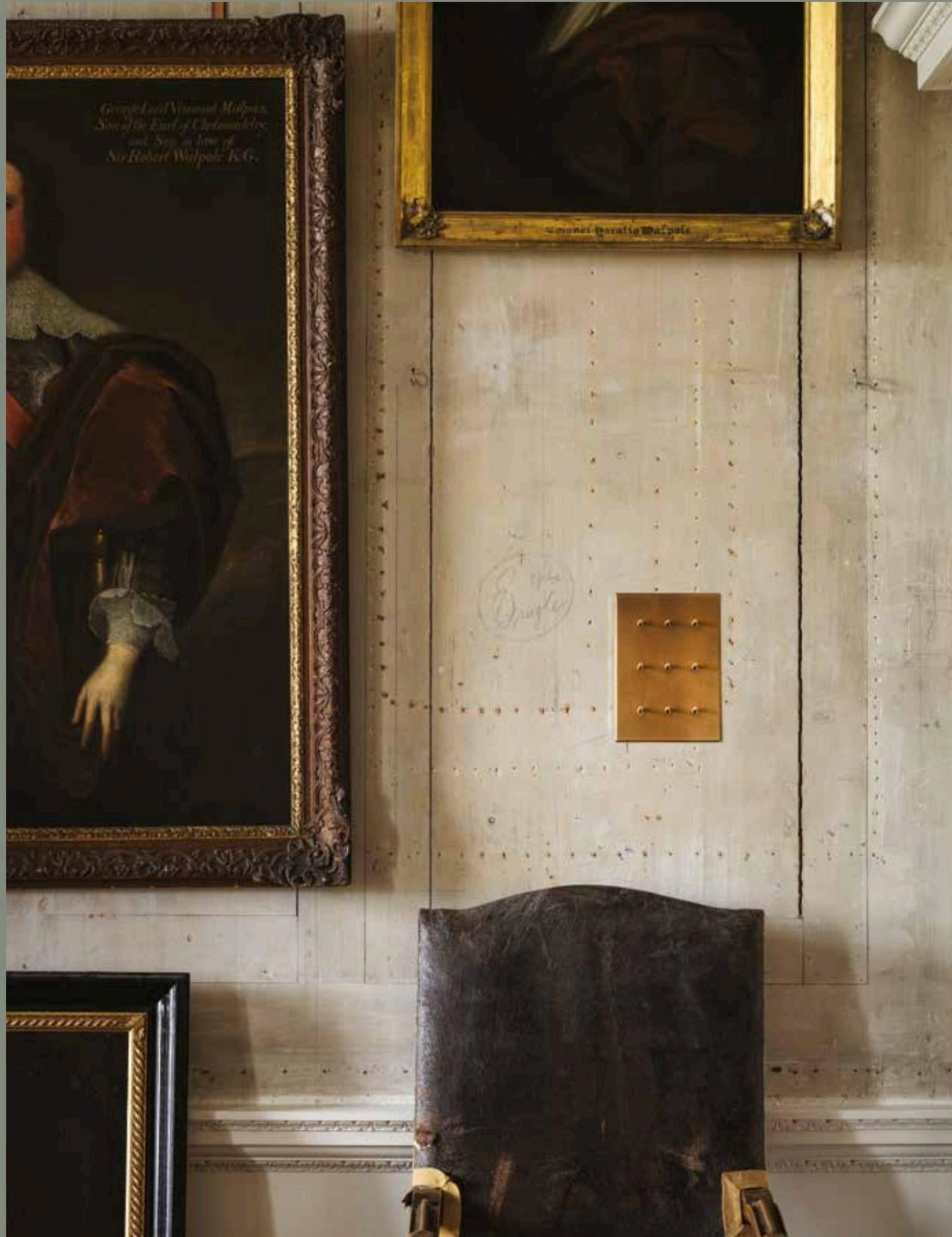

SECTION 3

Historic Royal Palaces: The Palaces Collection

A truly special collaboration with Historic Royal Palaces, the independent charity that cares for several renowned historic sites across the UK, The Palaces Collection is a range of switches inspired by the opulence, artistry and heritage of royal interiors. Handcrafted from solid brass, each piece echoes the grandeur of the palaces that inspired it: timeless in design, rich in story and quietly concealing state-of-the-art technology within.



HISTORIC ROYAL PALACES

The Palaces Collection

● AGED BRASS

Our Aged Brass finish embodies the history and craftsmanship of the palaces. Treated to evoke an antique appearance, it will add character and depth to your interior. This finish has a slight patina and subtle variations to mimic the effects of the past. Available in a wealth of options, our Palaces Collection switches are powered by industry-leading Enkin technology, offering intelligent dimming across the range.

THE SOHO LIGHTING CO.

9 GANG 2 WAY BALL TOGGLE SWITCH

Code: LTS309
From: £303



Explore *infinite* possibilities

This Aged Brass finish is available in over 55 switch and socket variations.

Go to **P.90** →



2 GANG 2 WAY CLASSIC TOGGLE SWITCH

Code: LTS302
From: £98

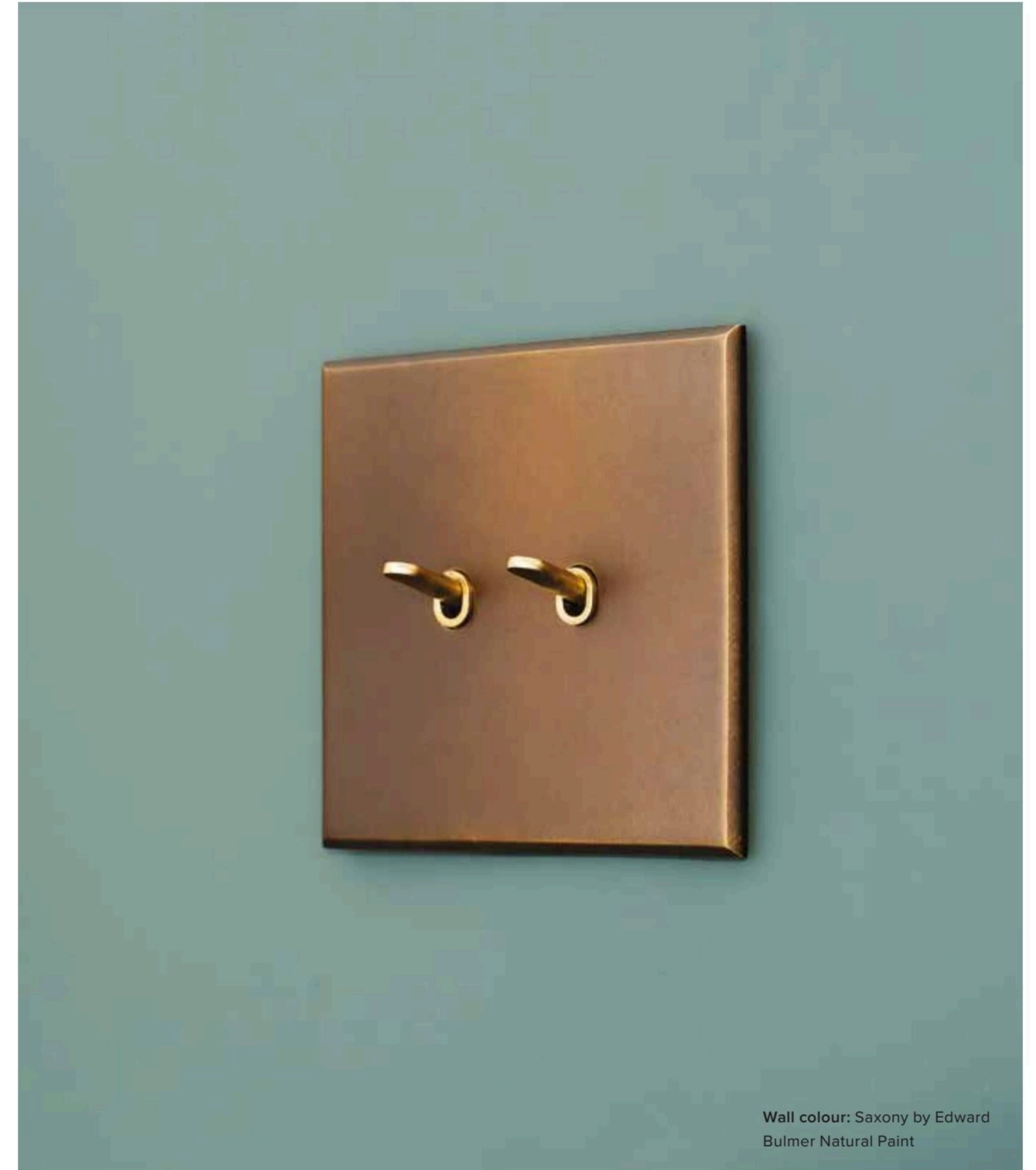

Wall colour: Saxony by Edward Bulmer Natural Paint

2 GANG 2 WAY PADDLE TOGGLE SWITCH

Code: LTS302
From: £100

Aged Brass Finish code:
KVB (Aged Brass & Black Inserts)

P. 63

HISTORIC ROYAL PALACES

The Palaces Collection

 **NATURAL BRASS**

Our Natural Brass finish encapsulates the beauty of brass in its raw state, offering a classic and sophisticated aesthetic, which will add warmth and elegance to any interior. Crafted from 4mm solid brass, the collection embodies classic elegance backed by state-of-the-art technology.

Available in a wealth of options, our Palaces Collection switches are powered by industry-leading Enkin technology, offering intelligent dimming across the range.

THE SOHO LIGHTING CO.



**9 GANG 2 WAY CLASSIC
TOGGLE SWITCH**

Code: LTS309
From: £303

Explore *infinite* possibilities

This Natural Brass finish is available in over 55 switch and socket variations.

Go to P.90 →



**2 GANG 2 WAY CLASSIC
TOGGLE SWITCH**

Code: LTS302
From: £100



Wall colour: Dove by Edward
Bulmer Natural Paint

**2 GANG 2 WAY CLASSIC
TOGGLE SWITCH**

Code: LTS302
From: £100

Natural Brass Finish code:
KBB (Natural Brass & Black Inserts)

P. 65

HISTORIC ROYAL PALACES The Palaces Collection

● HERITAGE BRONZE ● HERITAGE BRONZE & BRASS

Our Heritage Bronze has been expertly treated to evoke the rich patina of aged bronze, giving the hardware a rich, opulent tone. Echoing the historical provenance of the palaces' original switches, it conveys a depth and elegance in keeping with the traditional archetypes. Available in a wealth of options, our Palaces Collection switches are powered by industry-leading Enkin technology, offering intelligent dimming across the range.

9 GANG CLASSIC TOGGLE SWITCH

Code: LTS309
From: £303

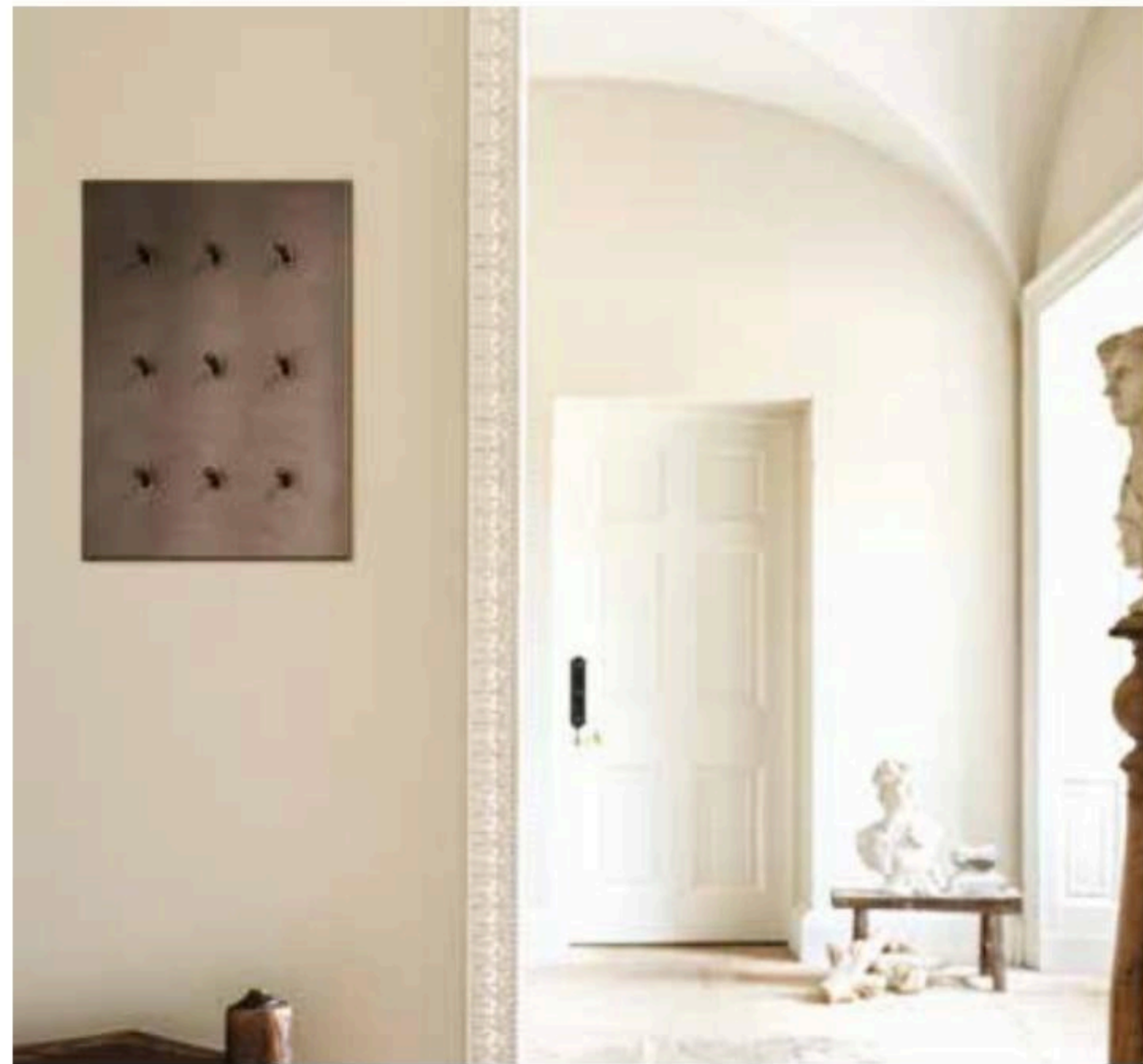

Explore *infinite* possibilities

This Heritage Bronze finish is available in over 55 switch and socket variations.

Go to **P.90** →



9 GANG BALL TOGGLE SWITCH

Code: LTS309
From: £303

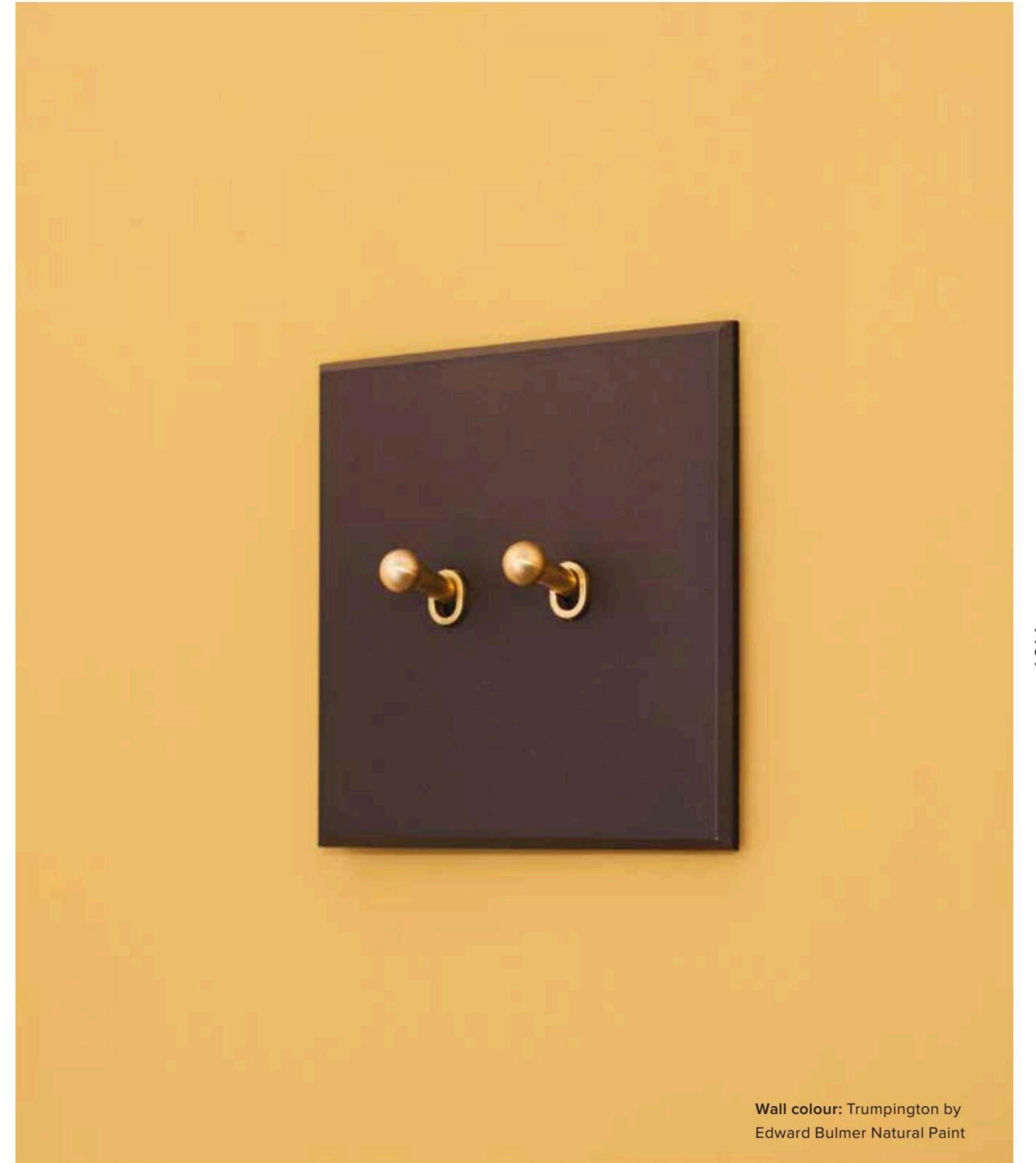

Wall colour: Trumpington by Edward Bulmer Natural Paint

2 GANG 2 WAY BALL TOGGLE SWITCH

Code: LTS302
From: £98

Heritage Bronze Finish code: **KZB** (Heritage Brass and Black inserts)

Coming soon...

HISTORIC ROYAL PALACES The Palaces Collection

● KING'S GOLD

Meticulously handcrafted to match finishes within the palaces, the collection is set to expand to incorporate additional exquisite precious metals that will bring a new level of opulence to the most distinguished interiors. King's Gold, inspired by Kensington Palace's gilded Cupola Room, is a market first finish created using a 24-carat gold blend. With the soft radiance of pale spun gold, it is unmatched in richness and refinement.

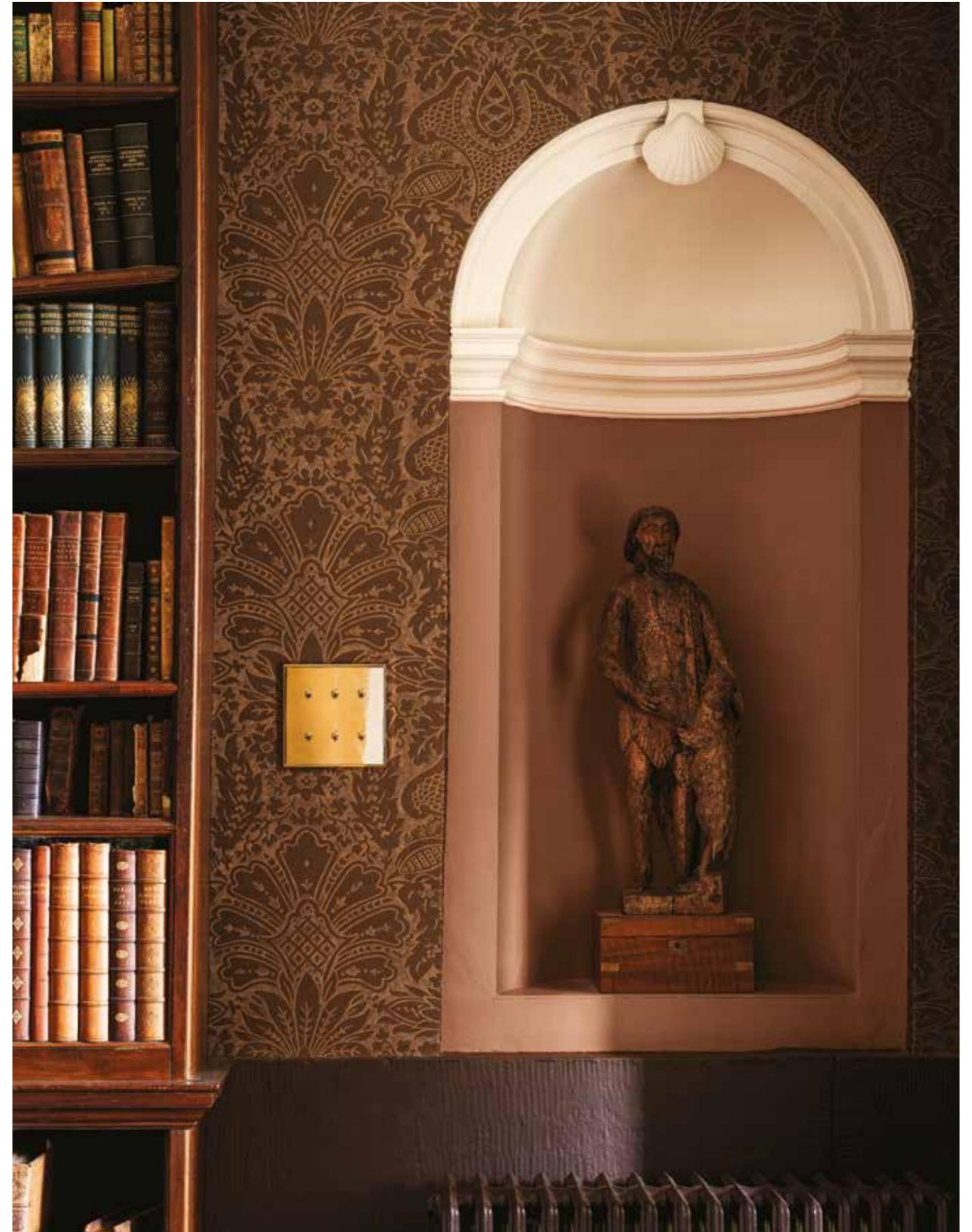
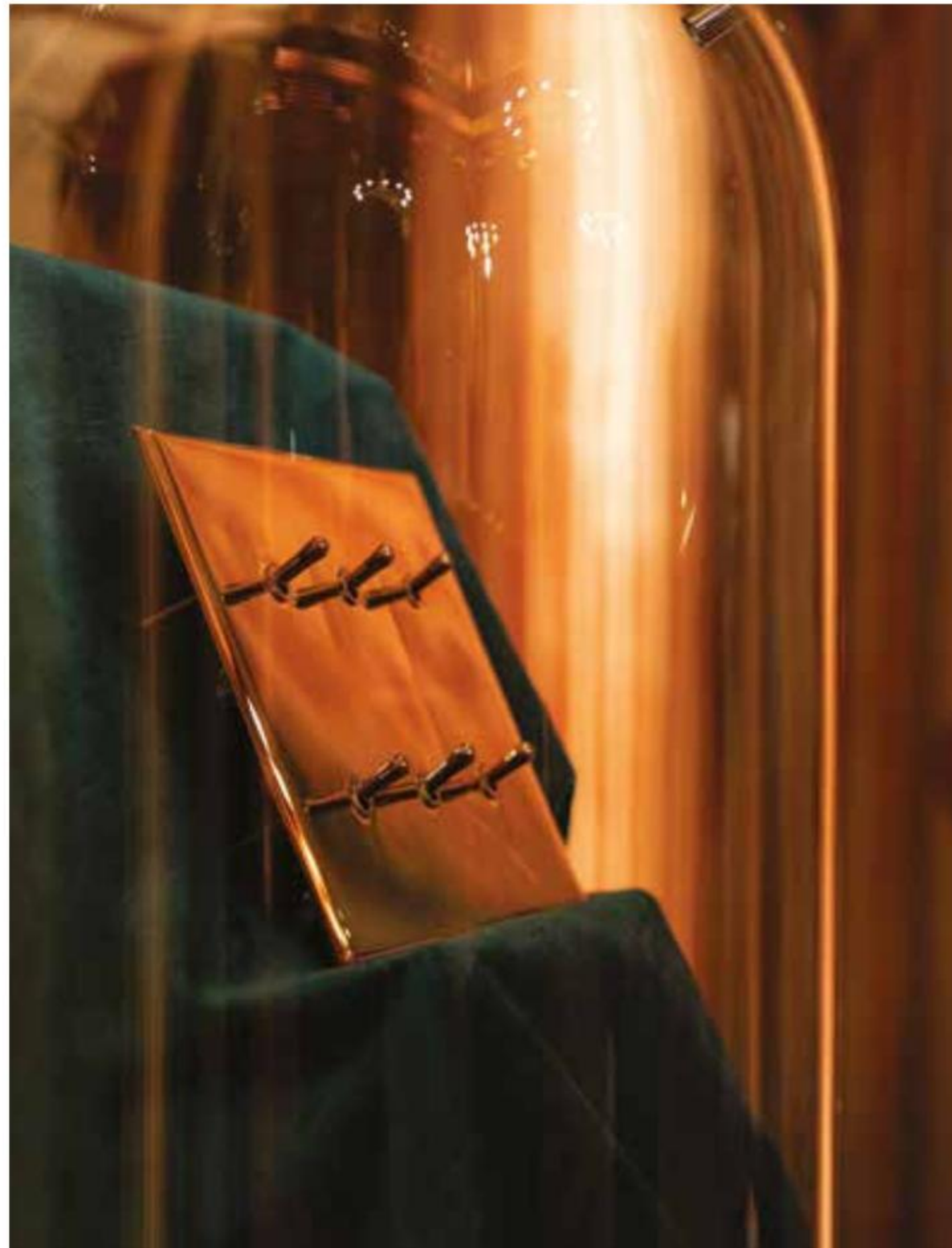

Coming soon...

HISTORIC ROYAL PALACES The Palaces Collection

● NICKEL

The ultimate in luxury finishes, our nickel plate echoes the chandeliers of Hampton Court Palace, exuding refined sophistication. Highly reflective, durable and lustrous, this statement-making, age-old finish is steeped in tradition and elegant beauty.



SOLID BRASS

Outdoor Switches & Sockets

Inspired by historic outdoor switches and sockets, these solid, hand cast brass pieces form part of our prestigious Chelsea Collection. The perfect blend of function and form, they will enhance the exterior beauty of your home and garden.

THE SOHO LIGHTING CO.



**IP65 OUTDOOR 20A 2-WAY
ROTARY LIGHT SWITCH**

Code: LTO101
From: £349

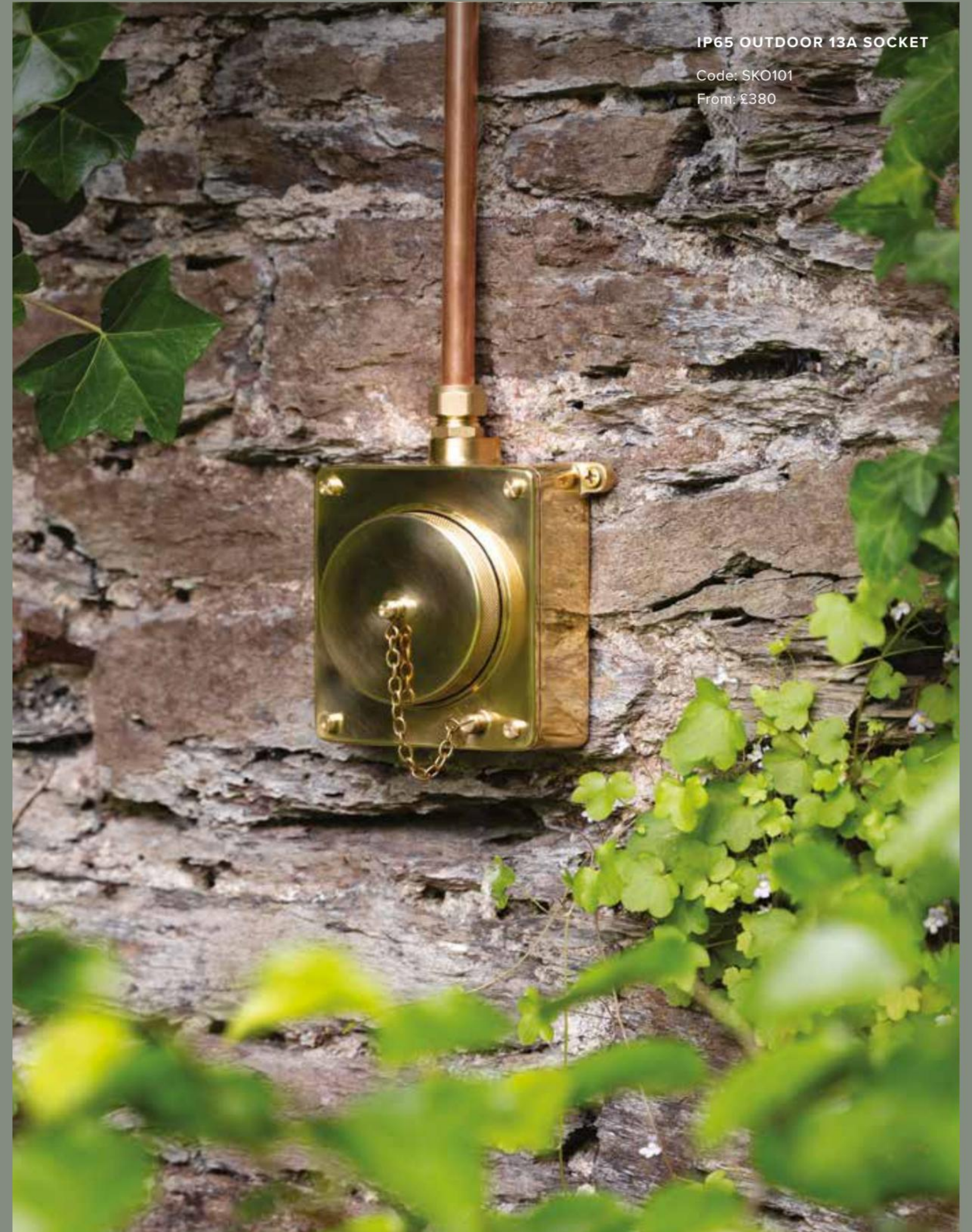

IP65 OUTDOOR 13A SOCKET

Code: SKO101
From: £380

INTRODUCING OUR PREBUILT
SWITCH & SOCKET OPTIONS





For Style & Simplicity

As lighting design and smart tech evolve, flexibility is key. That's why our Traditional, Flat and Historic Royal Palaces Collections offer over 150 prebuilt combinations – crafted to meet the demands of modern living with effortless style and convenience.

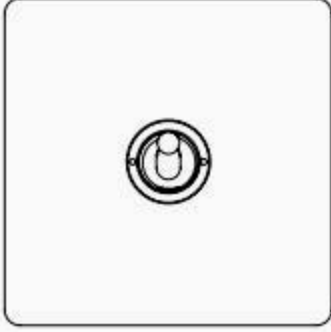
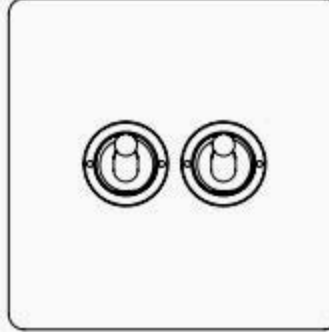

Light Switches

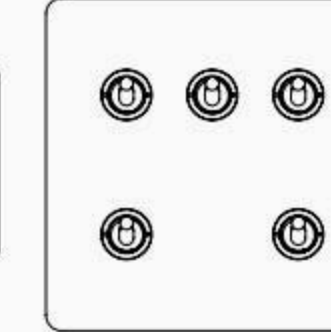
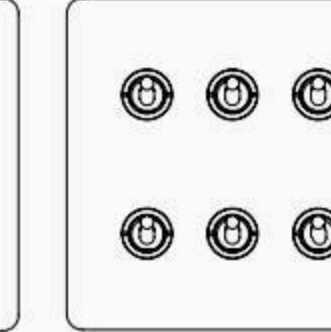
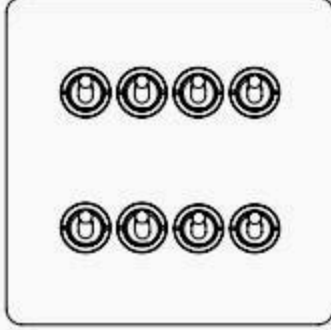
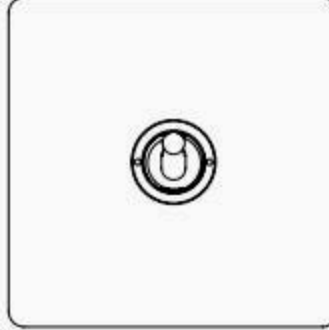
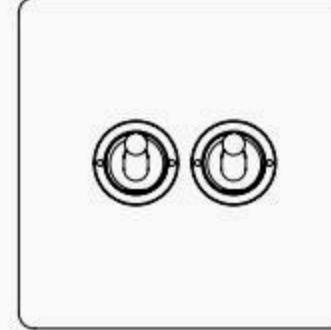
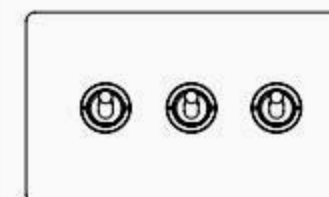
Toggle Switch

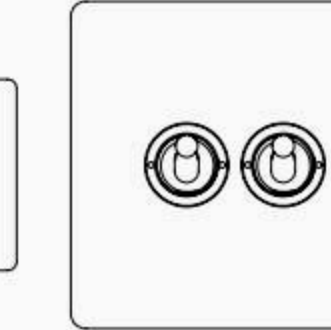
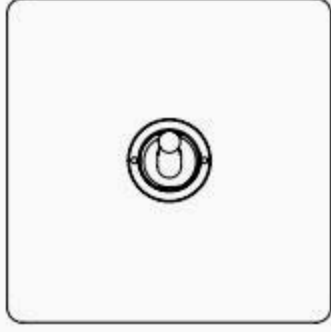
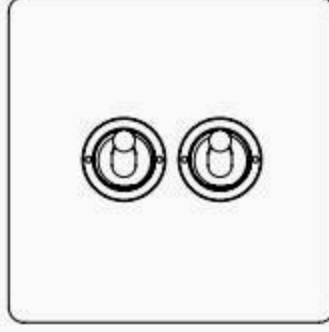
| | | | | | |
|--|--|---|--|---|---|
|  |  |  |  |  |  |
| 1 GANG 20A 2 WAY SWITCH Code: LTS301 From: £31.97 | 2 GANG 20A 2 WAY SWITCH Code: LTS302 From: £53 | 3 GANG 20A 2 WAY SWITCH Code: LTS303 From: £74 | 4 GANG 20A 2 WAY SWITCH Code: LTS304 From: £95 | 5 GANG 20A 2 WAY SWITCH Code: LTS305 From: £114 | 6 GANG 20A 2 WAY SWITCH Code: LTS306 From: £133 |
|  |  |  |  |  |  |
| 8 GANG 20A 2 WAY SWITCH Code: LTS308 From: £152 | 1 GANG INTERMEDIATE TOGGLE SWITCH Code: LTS311 From: £38 | 2 GANG INTERMEDIATE TOGGLE SWITCH Code: LTS312 From: £57 | 3 GANG INTERMEDIATE TOGGLE SWITCH Code: LTS313 From: £83 | 4 GANG INTERMEDIATE TOGGLE SWITCH Code: LTS314 From: £102 | 2 GANG 2-WAY & INTERMEDIATE SWITCH Code: LTS322 From: £62 |
|  |  | | | | |
| 1 GANG 20A 2 WAY RETRACTIVE SWITCH Code: LTS331 From: £36 | 2 GANG 20A 2 WAY RETRACTIVE SWITCH Code: LTS332 From: £58 | | | | |

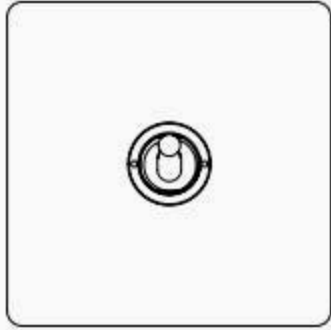
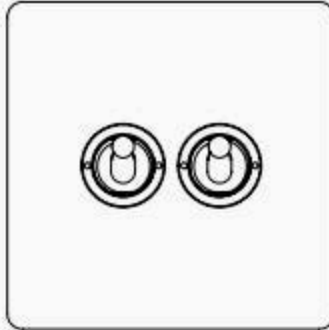
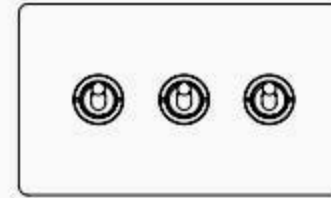
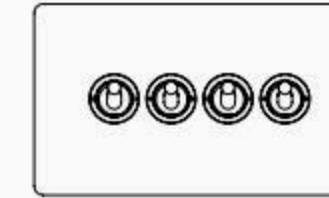
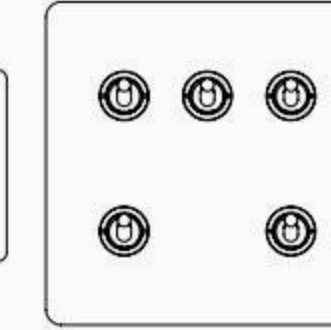
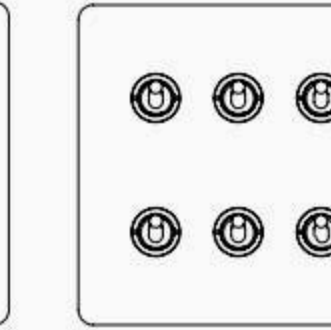
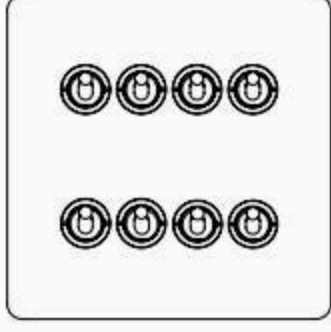

Dimmer Toggle Switch

| | | | | | |
|---|---|---|--|---|---|
|  |  |  |  |  |  |
| 1 GANG 2 WAY DIMMING TOGGLE SWITCH Code: LTS501 From: £45 | 2 GANG 2 WAY DIMMING TOGGLE SWITCH Code: LTS502 From: £74 | 3 GANG 2 WAY DIMMING TOGGLE SWITCH Code: LTS503 From: £111 | 4 GANG 2 WAY DIMMING TOGGLE SWITCH Code: LTS504 From: £130 | 5 GANG 2 WAY DIMMING TOGGLE SWITCH Code: LTS505 From: £179 | 6 GANG 2 WAY DIMMING TOGGLE SWITCH Code: LTS506 From: £207 |
|  | | | | | |
| 8 GANG 2 WAY DIMMING TOGGLE SWITCH Code: LTS508 From: £264 | | | | | |

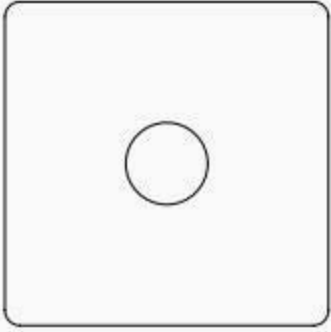
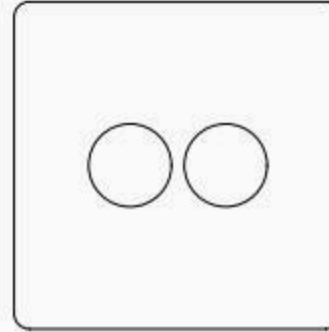
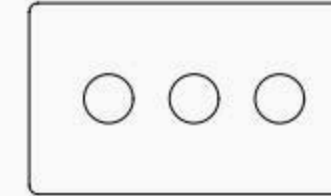
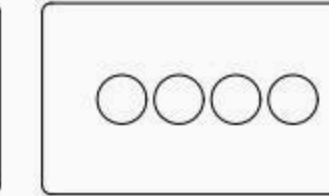
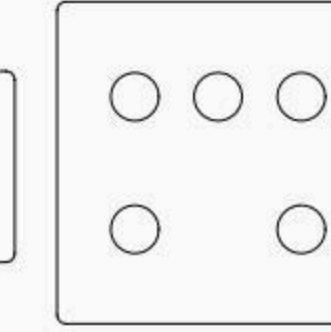
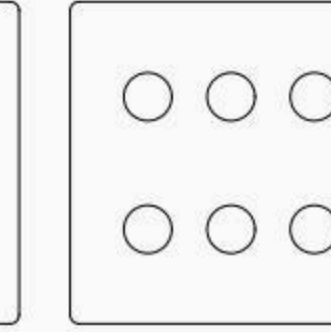
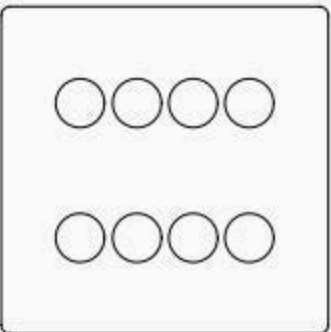
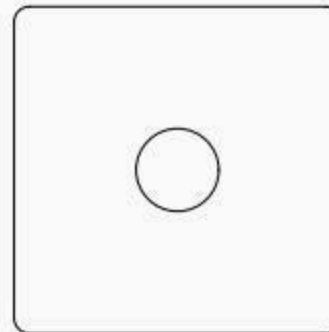
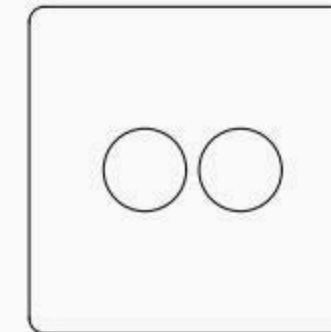

Smart Switch

| | | |
|---|---|---|
|  |  |  |
| 1 GANG 150W ZIGBEE SMART TOGGLE SWITCH Code: LTS351 From: £85.61 | 2 GANG 150W ZIGBEE SMART TOGGLE SWITCH Code: LTS352 From: £159.22 | 1 GANG 150W ZIGBEE SMART ROCKER SWITCH Code: LTS161 From: £72 |

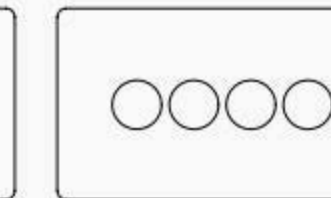
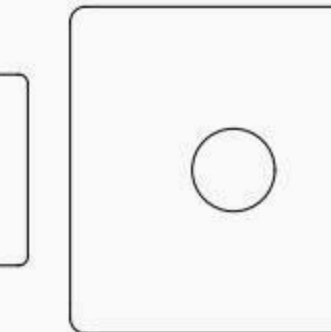
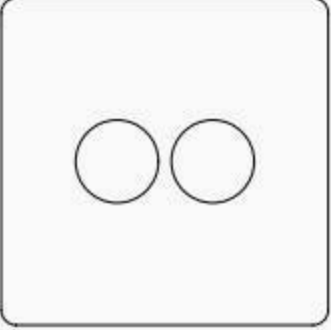
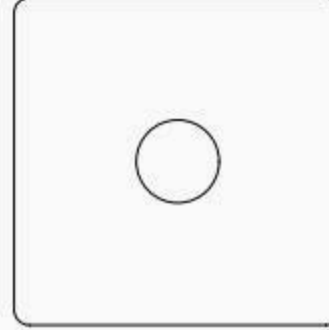
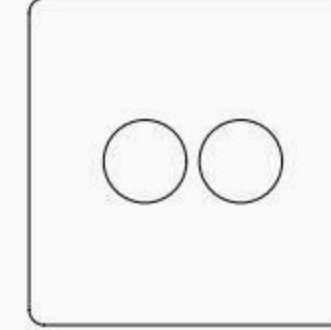

Rotary Dimmer

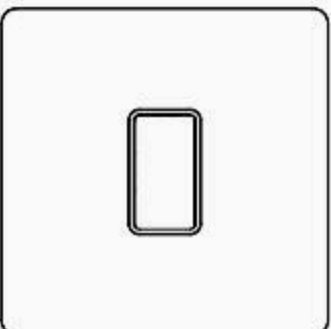
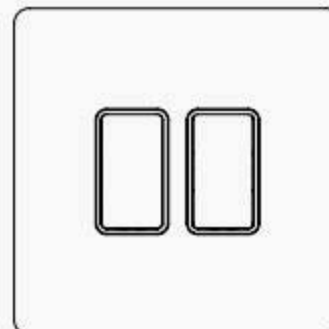
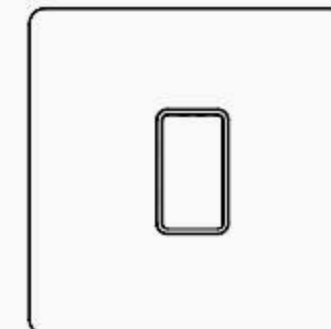
| | | | | | |
|---|---|---|---|---|--|
|  |  |  |  |  |  |
| 1 GANG 150W LED DIMMER SWITCH Code: LTS201 From: £29.98 | 2 GANG 150W LED DIMMER SWITCH Code: LTS202 From: £67 | 3 GANG 150W LED DIMMER SWITCH Code: LTS203 From: £111 | 4 GANG 150W LED DIMMER SWITCH Code: LTS204 From: £140 | 4 GANG 150W LED DIMMER SWITCH Code: LTS205 From: £170 | 6 GANG 150W LED DIMMER SWITCH Code: LTS216 From: £226 |
|  |  |  |  |  |  |
| 8 GANG 150W LED DIMMER SWITCH Code: LTS218 From: £292 | 1 GANG 400W LED DIMMER SWITCH Code: LTS241 From: £53 | 2 GANG 400W LED DIMMER SWITCH Code: LTS242 From: £93 | 3 GANG 400W LED DIMMER SWITCH Code: LTS243 From: £139 | 4 GANG 400W LED DIMMER SWITCH Code: LTS244 From: £175 | 1 GANG 250W LED MULTI-WAY DIMMER SWITCH Code: LTS251 From: £55 |
|  |  |  | | | |
| 2 GANG 250W LED MULTI-WAY DIMMER SWITCH Code: LTS252 From: £96 | 1 GANG 1000W DC1-10V DIMMER SWITCH Code: LTS261 From: £39 | 2 GANG 1000W DC1-10V DIMMER SWITCH Code: LTS262 From: £68 | | | |

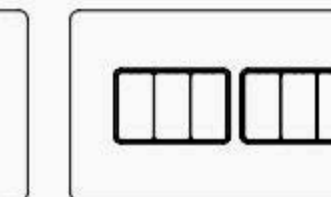
Rocker Switch

| | | | | | |
|---|---|---|---|---|---|
|  |  |  |  |  |  |
| 1 GANG 10A 2 WAY SWITCH Code: LTS101 From: £14.98 | 2 GANG 10A 2 WAY SWITCH Code: LTS102 From: £12.97 | 3 GANG 10A 2 WAY SWITCH Code: LTS103 From: £31 | 3 GANG 10A 2 WAY SWITCH DOUBLE PLATE Code: LTS123 From: £29 | 4 GANG 10A 2 WAY SWITCH Code: LTS104 From: £45 | 6 GANG 10A 2 WAY SWITCH Code: LTS106 From: £57 |

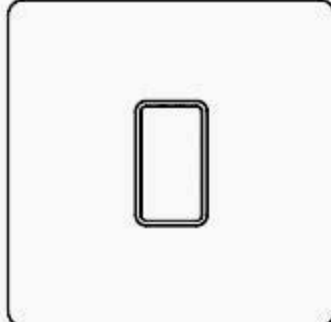
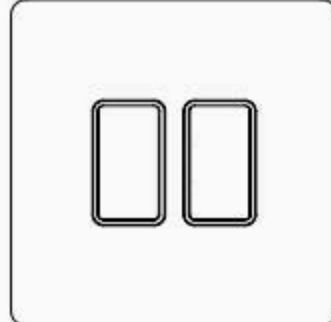
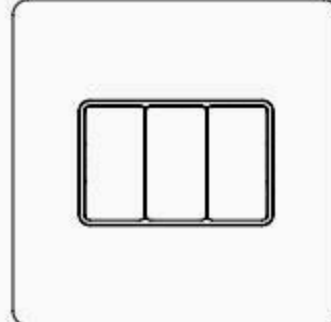
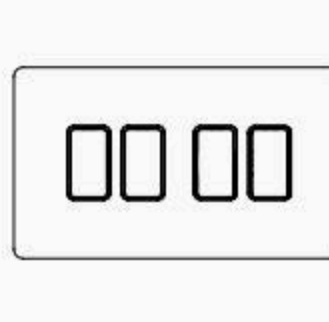
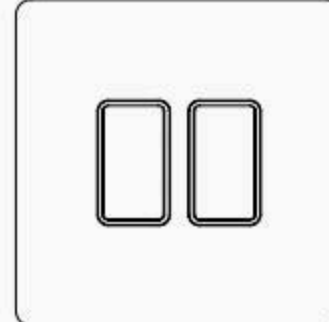
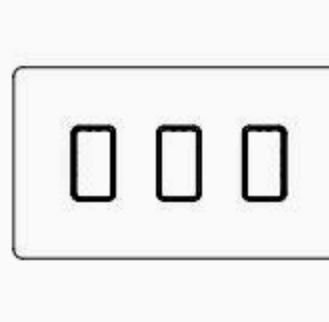

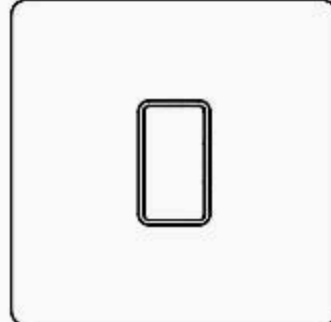
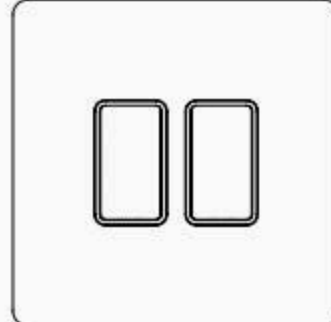
Rocker Switch
continued

| | | | | | |
|---|---|---|--|---|---|
|  |  |  |  |  |  |
| 1 GANG 10A INTERMEDIATE SWITCH Code: LTS111 From: £26 | 2 GANG 10A INTERMEDIATE SWITCH Code: LTS112 From: £31 | 3 GANG 10A INTERMEDIATE SWITCH Code: LTS113 From: £31 | 4 GANG 10A INTERMEDIATE SWITCH Code: LTS114 From: £47 | 2 GANG 2-WAY & INTERMEDIATE SWITCH Code: LTS138 From: £27 | 3 GANG 2 2-WAY & 1 INTERMEDIATE SWITCH Code: LTS137 From: £38 |
|  |  |  | | | |
| 4 GANG 3 2-WAY & 1 INTERMEDIATE SWITCH Code: LTS136 From: £44 | 1 GANG RETRACTIVE SWITCH Code: LTS141 From: £19 | 2 GANG RETRACTIVE SWITCH Code: LTS142 From: £26 | | | |

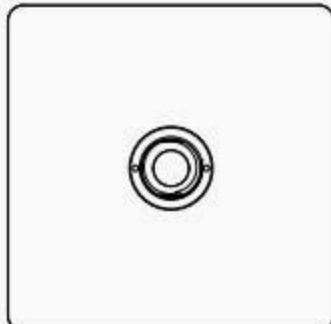
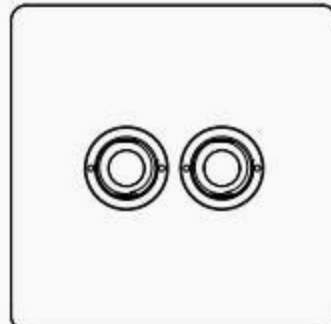
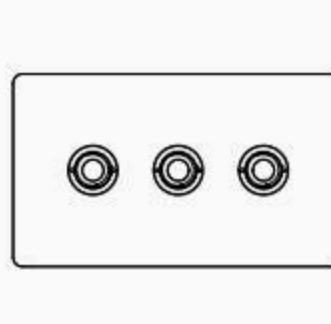
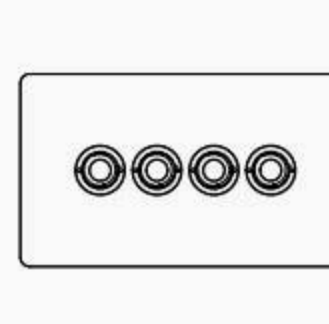
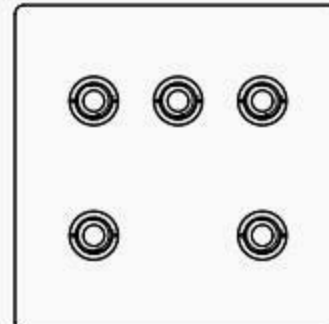
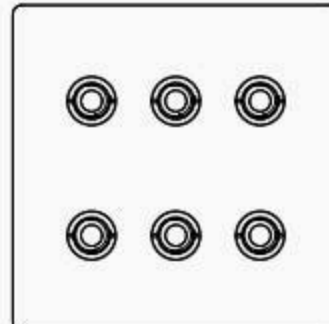
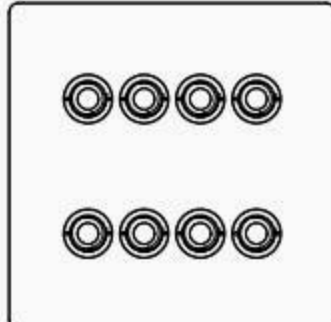
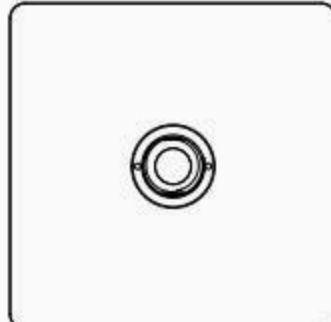
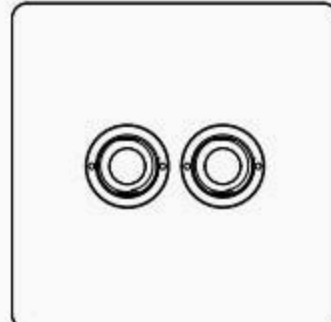
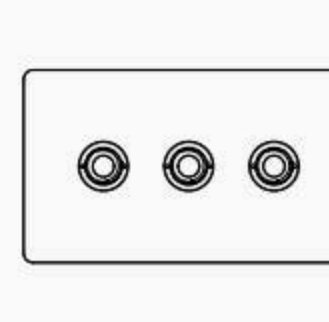
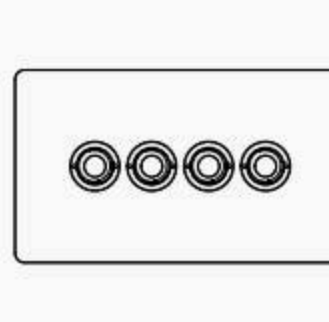
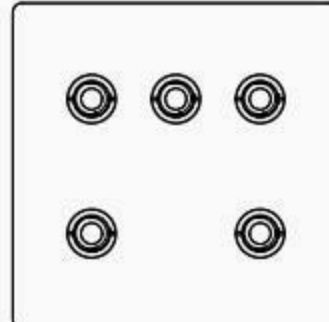
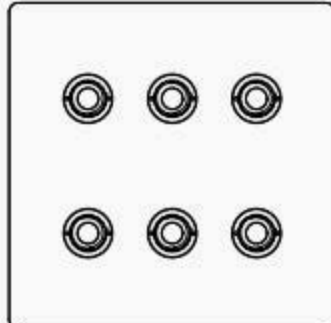
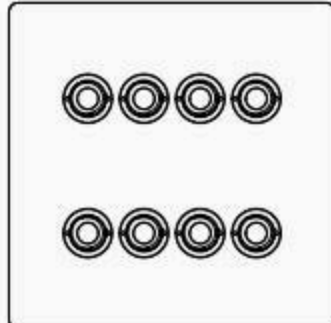
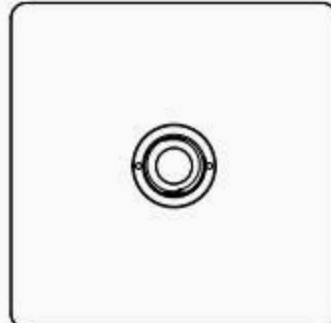
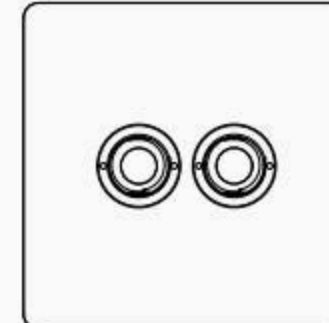
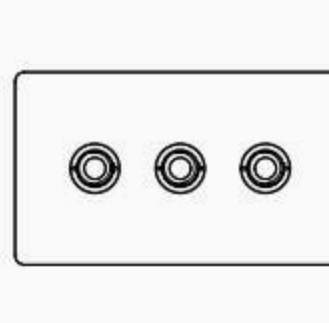
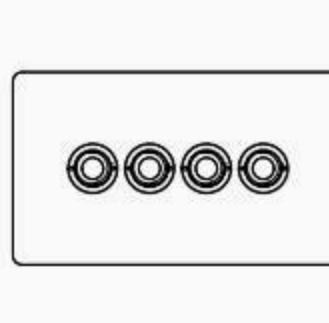
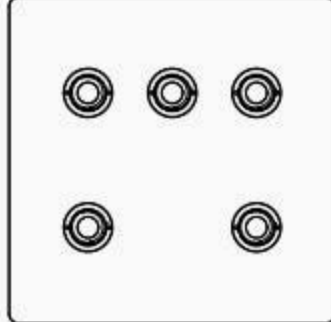
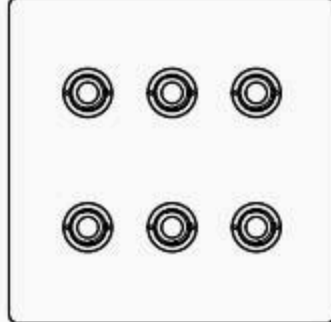
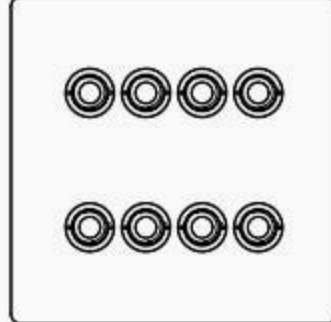
Push Button Switch

| | | | | | |
|---|---|---|--|---|---|
|  |  |  |  |  |  |
| 1 GANG 2 WAY PUSH BUTTON SWITCH Code: LTS601 From: £25 | 2 GANG 2 WAY PUSH BUTTON SWITCH Code: LTS602 From: £39 | 3 GANG 2 WAY PUSH BUTTON SWITCH Code: LTS603 From: £56 | 4 GANG 2 WAY PUSH BUTTON SWITCH Code: LTS604 From: £70 | 5 GANG 2 WAY PUSH BUTTON SWITCH Code: LTS605 From: £96 | 6 GANG 2 WAY PUSH BUTTON SWITCH Code: LTS606 From: £110 |
|  |  |  |  |  |  |
| 8 GANG 2 WAY PUSH BUTTON SWITCH Code: LTS608 From: £139 | 1 GANG 2 WAY RETRACTIVE PUSH BUTTON SWITCH Code: LTS641 From: £25 | 2 GANG 2 WAY RETRACTIVE PUSH BUTTON SWITCH Code: LTS642 From: £39 | 3 GANG 2 WAY RETRACTIVE PUSH BUTTON SWITCH Code: LTS643 From: £56 | 4 GANG 2 WAY RETRACTIVE PUSH BUTTON SWITCH Code: LTS644 From: £70 | 5 GANG 2 WAY RETRACTIVE PUSH BUTTON SWITCH Code: LTS645 From: £96 |
|  |  |  |  |  |  |
| 6 GANG 2 WAY RETRACTIVE PUSH BUTTON SWITCH Code: LTS646 From: £110 | 8 GANG 2 WAY RETRACTIVE PUSH BUTTON SWITCH Code: LTS648 From: £139 | 1 GANG PUSH BUTTON DIMMER SWITCH Code: LTS651 From: £46 | 2 GANG PUSH BUTTON DIMMER SWITCH Code: LTS652 From: £81 | 3 GANG PUSH BUTTON DIMMER SWITCH Code: LTS653 From: £120 | 4 GANG PUSH BUTTON DIMMER SWITCH Code: LTS654 From: £155 |
|  |  |  | | | |
| 5 GANG PUSH BUTTON DIMMER SWITCH Code: LTS655 From: £202 | 6 GANG PUSH BUTTON DIMMER SWITCH Code: LTS656 From: £237 | 8 GANG PUSH BUTTON DIMMER SWITCH Code: LTS658 From: £308 | | | |

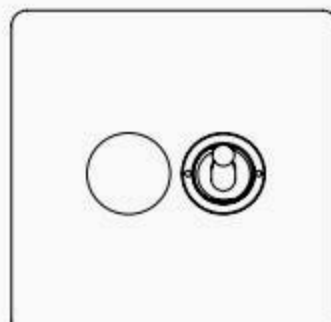
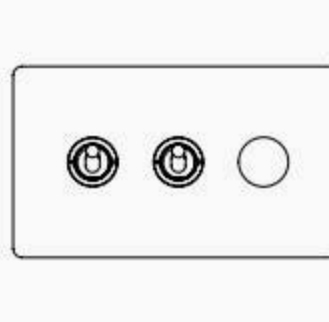
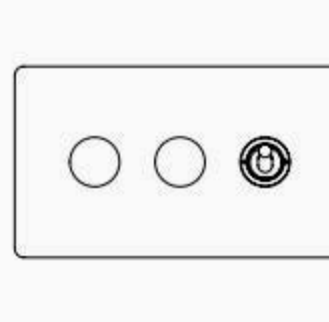
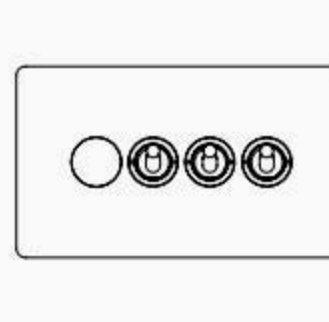
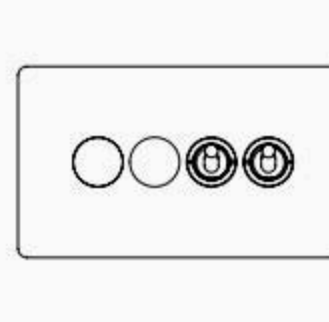
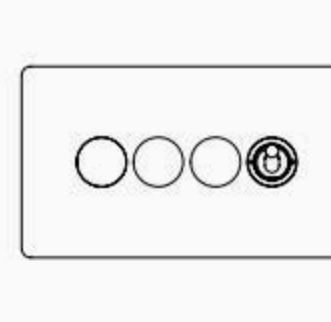
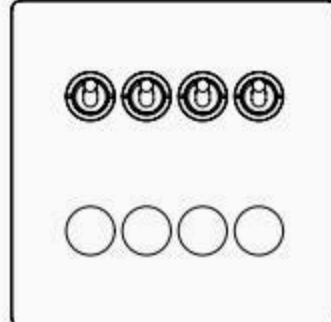
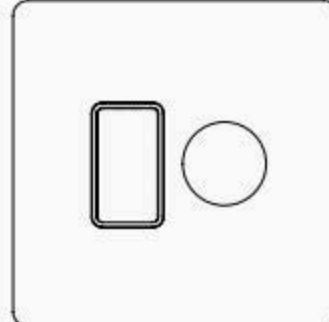
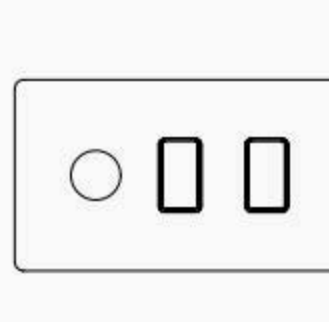
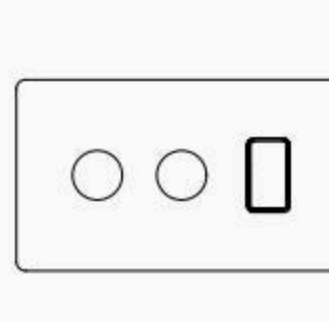
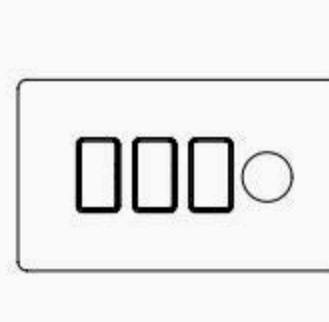
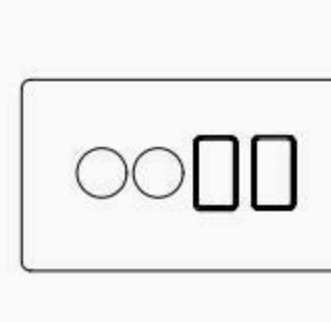
Combination Switch

| | | | | | |
|---|---|---|---|---|---|
|  |  |  |  |  |  |
| 2 GANG DIMMER AND TOGGLE COMBO SWITCH Code: LTS341 From: £60 | 3 GANG 1 DIMMER AND 2 TOGGLE COMBO SWITCH Code: LTS342 From: £88 | 3 GANG 2 DIMMER AND 1 TOGGLE COMBO SWITCH Code: LTS343 From: £100 | 4 GANG 1 DIMMER AND 3 TOGGLE COMBO SWITCH Code: LTS344 From: £101 | 4 GANG 2 DIMMER AND 2 TOGGLE COMBO SWITCH Code: LTS345 From: £113 | 4 GANG 3 DIMMER AND 1 TOGGLE COMBO SWITCH Code: LTS346 From: £127 |
|  |  |  |  |  |  |
| 8 GANG 4 DIMMER AND 4 TOGGLE COMBO SWITCH Code: LTS381 From: £251 | 2 GANG DIMMER AND ROCKER COMBO SWITCH Code: LTS132 From: £52 | 3 GANG 1 DIMMER AND 2 ROCKER COMBO SWITCH Code: LTS130 From: £63 | 3 GANG 2 DIMMER AND 1 ROCKER COMBO SWITCH Code: LTS131 From: £90 | 4 GANG 1 DIMMER AND 3 ROCKER COMBO SWITCH Code: LTS153 From: £94 | 4 GANG 2 DIMMER AND 2 ROCKER COMBO SWITCH Code: LTS152 From: £106 |
|  | | | | | |
| 4 GANG 3 DIMMER AND 1 ROCKER COMBO SWITCH Code: LTS151 From: £122 | | | | | |

Sockets

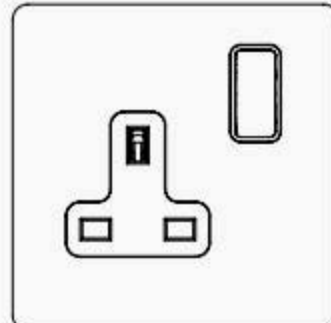
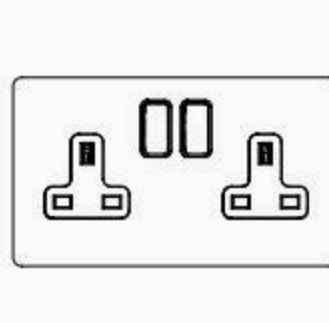
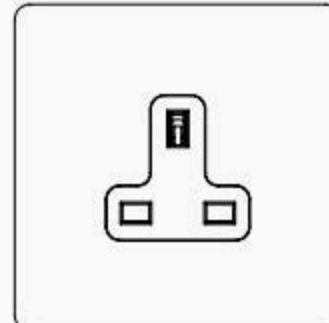
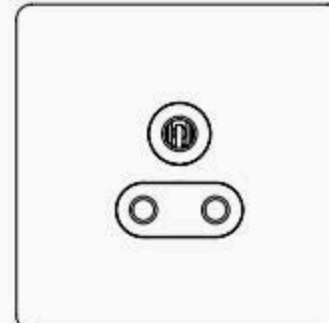
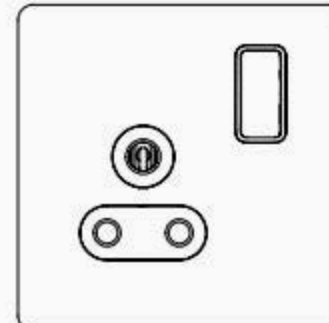
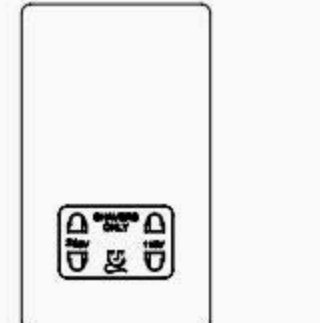
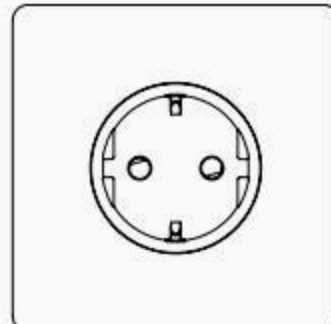
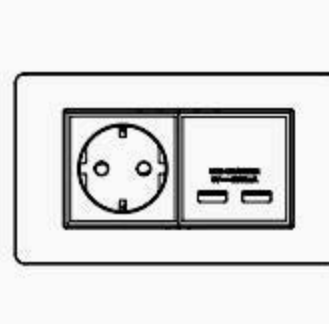
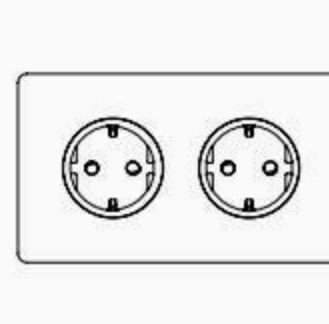
| | | | | | |
|---|---|---|---|---|---|
|  |  |  |  |  |  |
| 1 GANG DP SOCKET Code: SKT101 From: £19 | 2 GANG DP SOCKET Code: SKT102 From: £14.98 | 1 GANG DP SOCKET UNSWITCHED Code: SKT103 From: £20 | 5A SOCKET Code: SKT301 From: £24 | 5A SWITCHED SOCKET Code: SKT302 From: £26 | 230V/115V DUAL VOLTAGE SHAVER SOCKET Code: SKT401 From: £54 |
|  |  |  | | | |
| 1 GANG 16A SCHUKO SOCKET Code: SKT601 From: £16 | 2 GANG EUROPEAN SCHUKO SOCKET WITH USB Code: SKT612 From: £53 | 2 GANG 16A SCHUKO SOCKET Code: SKT602 From: £27 | | | |

USB Socket

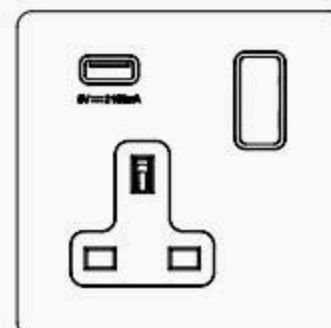

1 GANG 2.1A USB-A SOCKET
Code: SKT201
From: £34

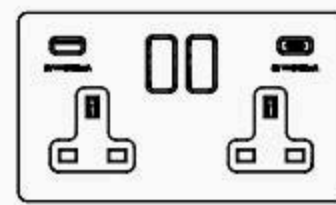

2 GANG 3.1A USB-A SOCKET
Code: SKT202
From: £35

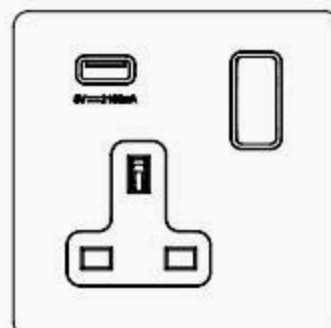

1 GANG 2.1A USB-A SOCKET
Code: SKT211
From: £31

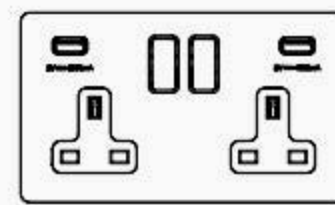

2 GANG 4.8A USB-A SOCKET
Code: SKT212
From: £38

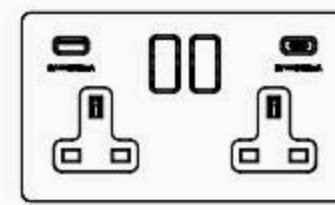

2 GANG 3.1A USB-A+C SOCKET
Code: SKT204
From: £34.98

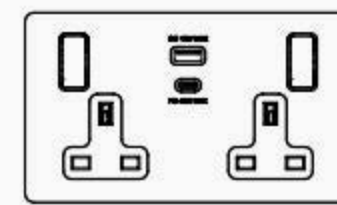

2 GANG SUPER FAST USB A+C SOCKET
Code: SKT214
From: £59

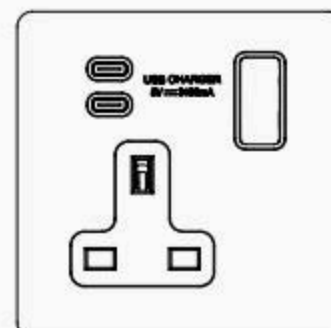

1 GANG DP SOCKET C+C USB
Code: SKT221
From: £34.98

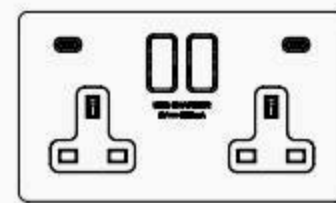

2 GANG DP SOCKET C+C USB
Code: SKT222
From: £39.97

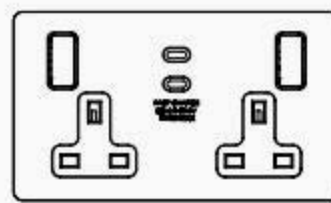

2 GANG 65W USB C+C SOCKET
Code: SKT215
From: £59.99

Floor Socket

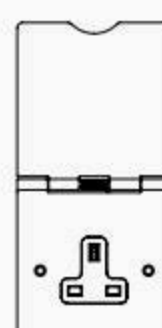

1 GANG 13A FLOOR SOCKET
Code: SKT501
From: £18

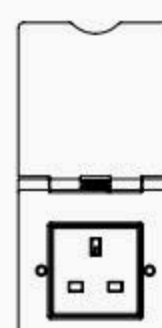

1 GANG 13A EUROMOD FLOOR SOCKET
Code: SKT507
From: £26

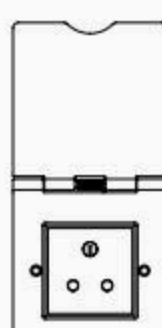

1 GANG 5 AMP FLOOR SOCKET
Code: SKT503
From: £26

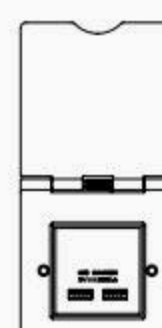

1 GANG USB FLOOR SOCKET
Code: SKT504
From: £46

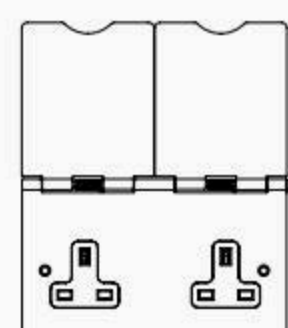

2 GANG 13A FLOOR SOCKET
Code: SKT502
From: £24.98

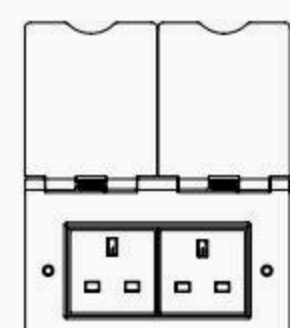

2 GANG 13A EUROMOD FLOOR SOCKET
Code: SKT508
From: £37

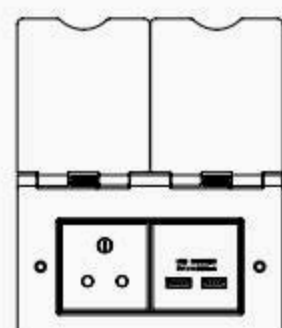

2 GANG USB & 5A FLOOR SOCKET
Code: SKT506
From: £61

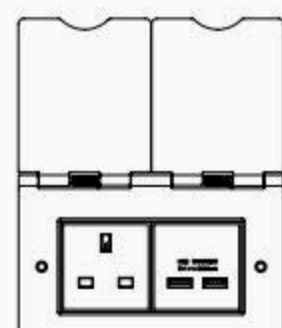

2 GANG USB & 13A FLOOR SOCKET
Code: SKT505
From: £61

Media Sockets

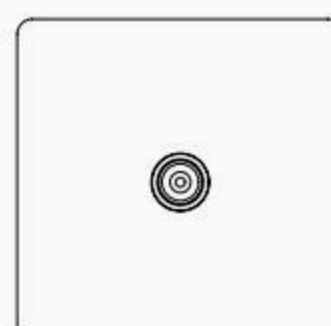

1 GANG COAXIAL TV AERIAL SOCKET
Code: MED101
From: £22

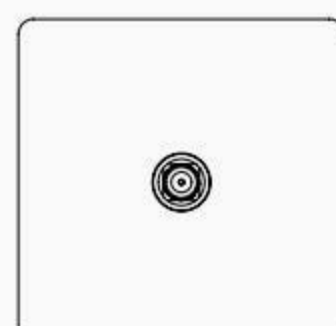

1 GANG SATELLITE SOCKET
Code: MED102
From: £23

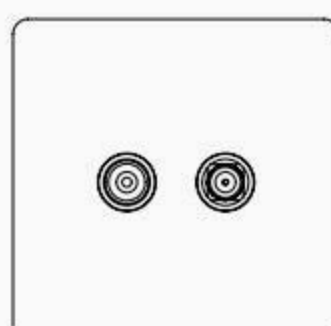

TV & SATELLITE SOCKET
Code: MED103
From: £16

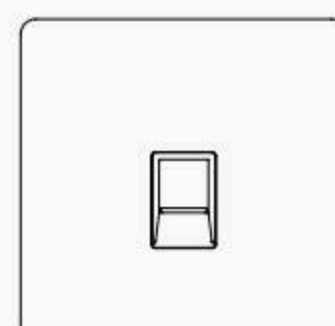

1 GANG BT MASTER TELEPHONE SOCKET
Code: MED201
From: £24.98

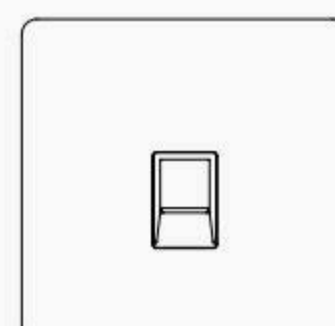

1 GANG BT SECONDARY TELEPHONE SOCKET
Code: MED202
From: £25

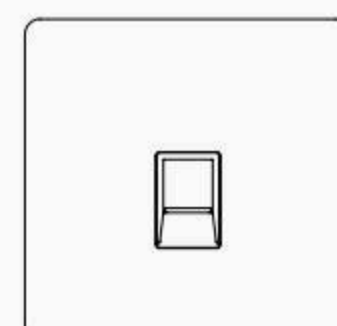

1 GANG CAT5/CAT6 RJ45 ETHERNET DATA SOCKET
Code: MED301
From: £26

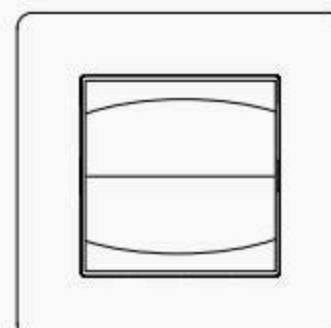

1 GANG BRUSH PLATE
Code: MED602
From: £24

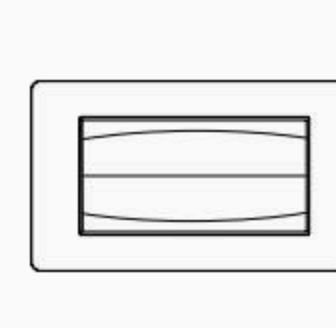

2 GANG BRUSH PLATE
Code: MED604
From: £29

Blank Plates



SINGLE BLANK PLATE
Code: PLT501
From: £5.27



DOUBLE BLANK PLATE
Code: PLT502
From: £23



6-8 GANG BLANK PLATE
Code: GRD568
From: £31



9-12 GANG BLANK PLATE
Code: GRD591
From: £36

Isolator Switches

45A Switch

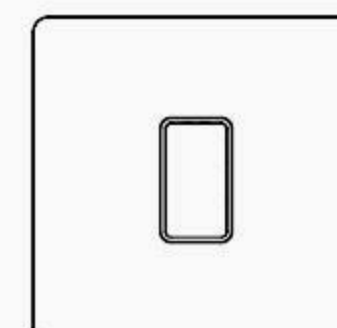

1 GANG 45A DP SWITCH - SINGLE
Code: ISO451
From: £42

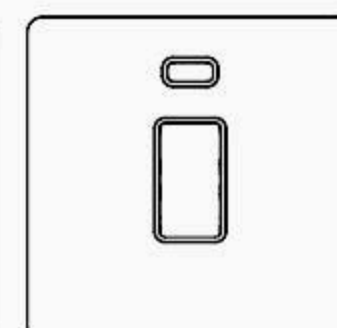

1 GANG 45A DP SWITCH - SINGLE WITH NEON
Code: ISO452
From: £44

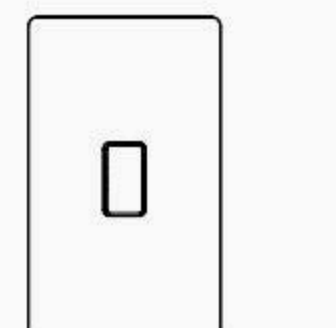

1 GANG 45A DP SWITCH - DOUBLE
Code: ISO453
From: £54

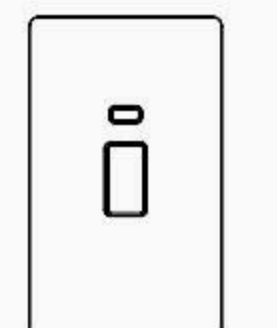

1 GANG 45A DP SWITCH - DOUBLE WITH NEON
Code: ISO454
From: £56

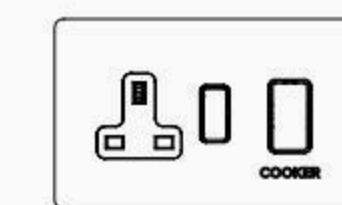

45A COOKER CONTROL UNIT
Code: ISO455
From: £48

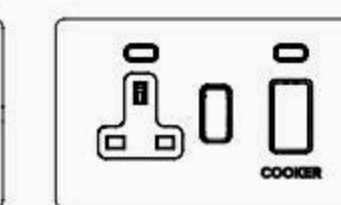

45A COOKER CONTROL UNIT WITH NEON
Code: ISO456
From: £50

Fused Spur

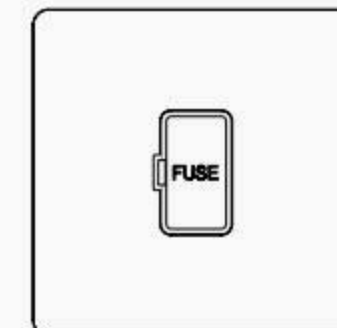

13A UNSWITCHED FUSED SPUR
Code: ISO131
From: £28

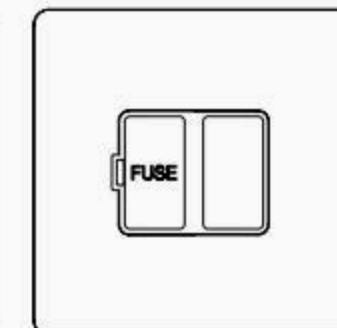

13A SWITCHED FUSED SPUR
Code: ISO133
From: £24

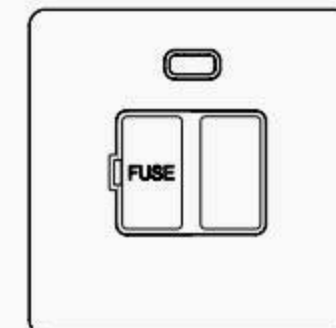

13A UNSWITCHED FUSED SPUR & NEON
Code: ISO134
From: £32

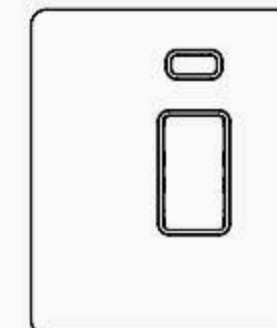

13A UNSWITCHED FUSED SPUR & FLEX OUTLET
Code: ISO132
From: £28

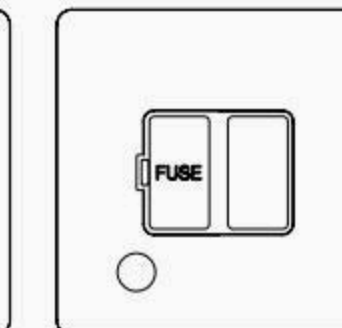

13A SWITCHED FUSED SPUR & FLEX OUTLET
Code: ISO135
From: £30

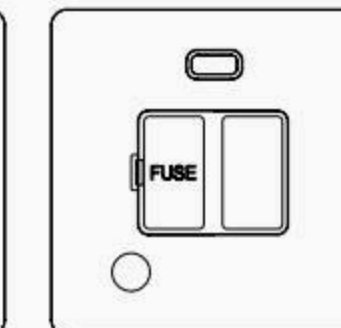

13A SWITCHED FUSED SPUR & FLEX OUTLET & NEON
Code: ISO136
From: £32

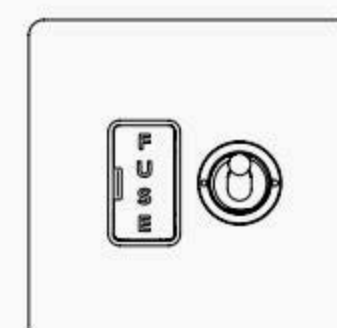

13A TOGGLE SWITCHED FUSED SPUR
Code: ISO320
From: £45

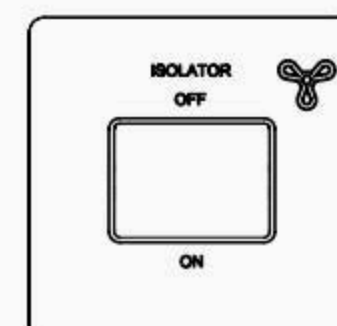

10A EXTRACTOR FAN ISOLATOR
Code: ISO101
From: £30

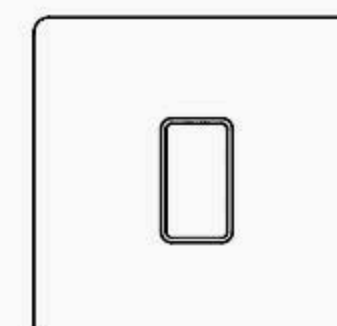

1 GANG 20A DP SWITCH
Code: ISO201
From: £29

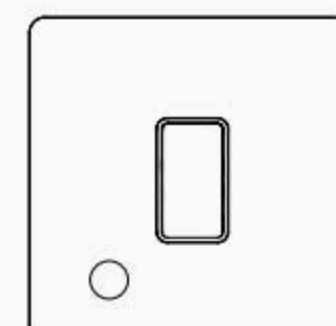

1 GANG 20A DP SWITCH & FLEX OUTLET
Code: ISO203
From: £32



1 GANG 20A DP SWITCH & FLEX OUTLET & NEON
Code: ISO202
From: £35

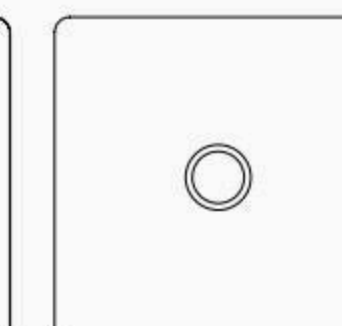

20A FLEX OUTLET
Code: PLT421
From: £18

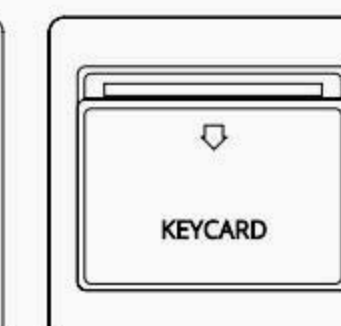

32A KEY CARD SWITCH
Code: ISO102
From: £50

Light Switches

Toggle Switch

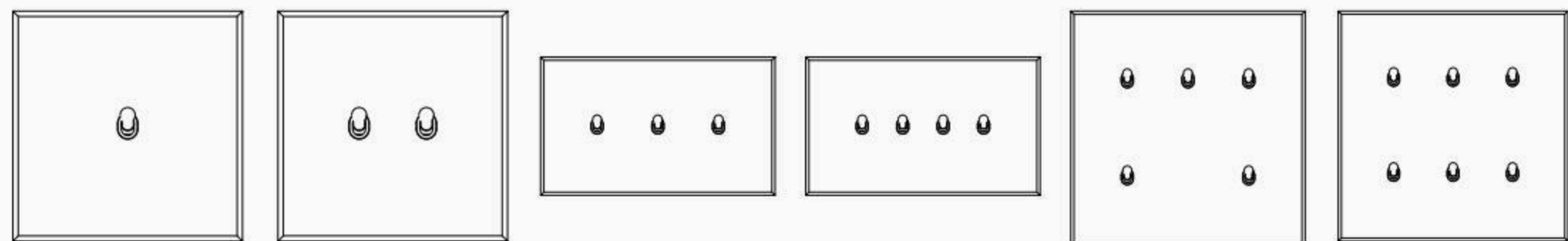

1 GANG 20A 2 WAY SWITCH
Code: LTS301
From: £82

2 GANG 20A 2 WAY SWITCH
Code: LTS302
From: £98

3 GANG 20A 2 WAY SWITCH
Code: LTS303
From: £131

4 GANG 20A 2 WAY SWITCH
Code: LTS304
From: £147

5 GANG 20A 2 WAY SWITCH
Code: LTS305
From: £219

6 GANG 20A 2 WAY SWITCH
Code: LTS306
From: £219

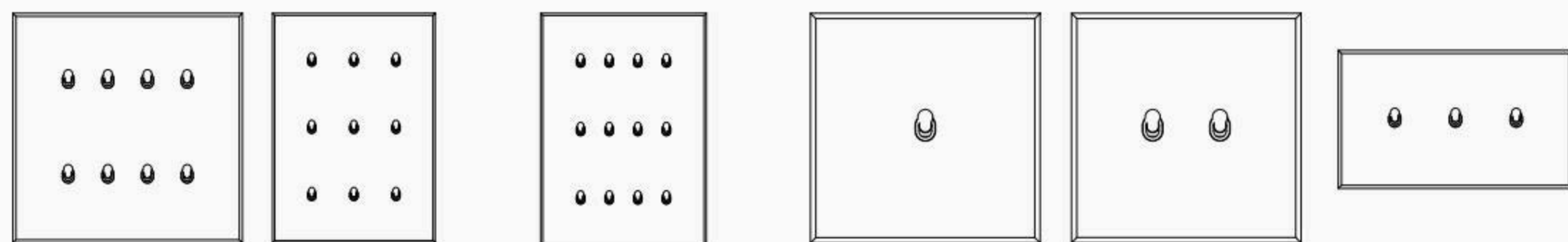

8 GANG 20A 2 WAY SWITCH
Code: LTS308
From: £250

9 GANG 20A 2 WAY SWITCH
Code: LTS309
From: £303

12 GANG 20A 2 WAY SWITCH
Code: LTS310
From: £351

1 GANG 20A INTERMEDIATE SWITCH
Code: LTS311
From: £84

2 GANG 20A INTERMEDIATE SWITCH
Code: LTS312
From: £101

3 GANG 20A INTERMEDIATE SWITCH
Code: LTS313
From: £136

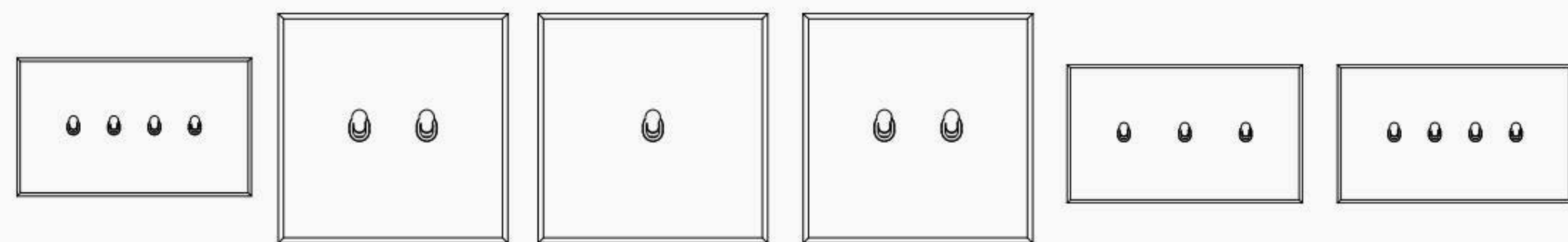

4 GANG 20A INTERMEDIATE SWITCH
Code: LTS314
From: £154

2 GANG 2-WAY & INTERMEDIATE SWITCH
Code: LTS322
From: £100

1 GANG 20A 2 WAY RETRACTIVE SWITCH
Code: LTS331
From: £83

2 GANG 20A 2 WAY RETRACTIVE SWITCH
Code: LTS332
From: £100

3 GANG 20A 2 WAY RETRACTIVE SWITCH
Code: LTS333
From: £134

4 GANG 20A 2 WAY RETRACTIVE SWITCH
Code: LTS334
From: £151

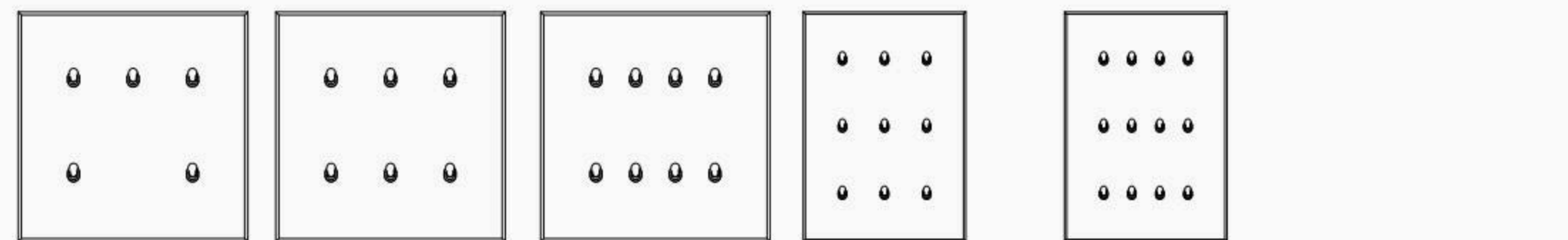

5 GANG 20A 2 WAY RETRACTIVE SWITCH
Code: LTS335
From: £224

6 GANG 20A 2 WAY RETRACTIVE SWITCH
Code: LTS336
From: £224

8 GANG 20A 2 WAY RETRACTIVE SWITCH
Code: LTS338
From: £258

9 GANG 20A 2 WAY RETRACTIVE SWITCH
Code: LTS339
From: £213

12 GANG 20A 2 WAY RETRACTIVE SWITCH
Code: LTS340
From: £363

Dimmer Toggle Switch

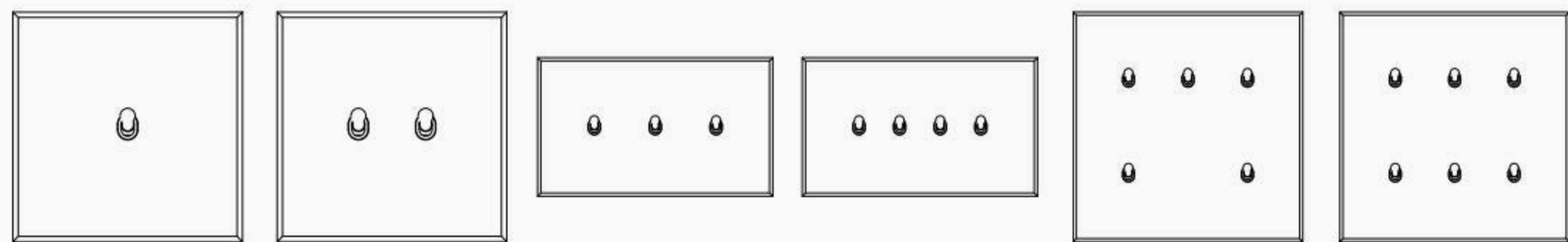

1 GANG 2 WAY DIMMING TOGGLE SWITCH
Code: LTS501
From: £105

2 GANG 2 WAY DIMMING TOGGLE SWITCH
Code: LTS502
From: £143

3 GANG 2 WAY DIMMING TOGGLE SWITCH
Code: LTS503
From: £199

4 GANG 2 WAY DIMMING TOGGLE SWITCH
Code: LTS504
From: £237

5 GANG 2 WAY DIMMING TOGGLE SWITCH
Code: LTS505
From: £331

6 GANG 2 WAY DIMMING TOGGLE SWITCH
Code: LTS506
From: £353

Dimmer Toggle Switch continued

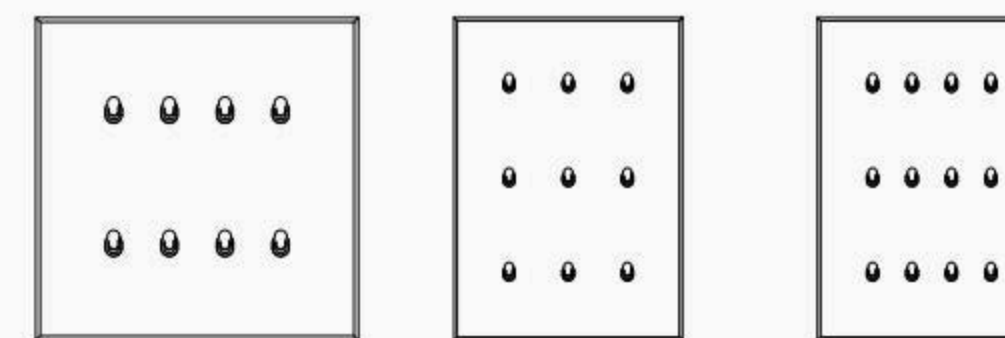

8 GANG 2 WAY DIMMING TOGGLE SWITCH
Code: LTS508
From: £430

9 GANG 2 WAY DIMMING TOGGLE SWITCH
Code: LTS509
From: £506

12 GANG 2 WAY DIMMING TOGGLE SWITCH
Code: LTS510
From: £621

Sockets

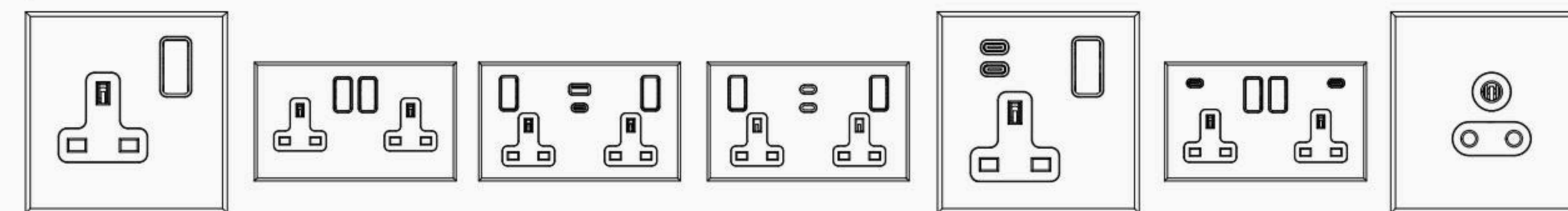

1 GANG DP SOCKET
Code: SKT101
From: £70

2 GANG DP SOCKET
Code: SKT102
From: £98

2 GANG SUPER FAST USB A+C SOCKET
Code: SKT214
From: £17BC

2 GANG SOCKET 65W MAX PD C+C USB
Code: SKT215
From: £154

1 GANG DP SOCKET C+C USB
Code: SKT221
From: £92

2 GANG DP SOCKET C+C USB
Code: SKT222
From: £130

5A UNSOCKET
Code: SKT301
From: £59

Media Sockets

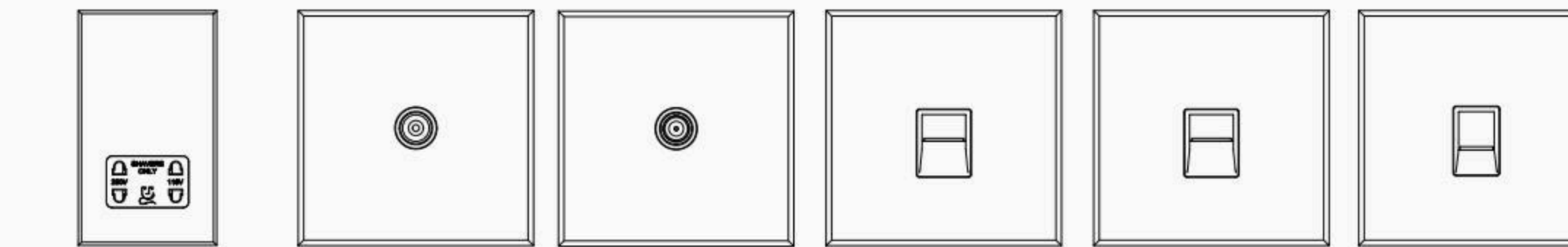

230V/115V DUAL VOLTAGE SHAVER SOCKET
Code: SKT401
From: £120

1 GANG COAXIAL TV AERIAL SOCKET
Code: MED101
From: £67

1 GANG SATELLITE SOCKET
Code: MED102
From: £68

1 GANG BT MASTER TELEPHONE SOCKET
Code: MED201
From: £71

1 GANG BT SECONDARY TELEPHONE SOCKET
Code: MED202
From: £68

1 GANG CAT5/CAT6 RJ45 ETHERNET DATA SOCKET
Code: MED301
From: £69

Blank Plates

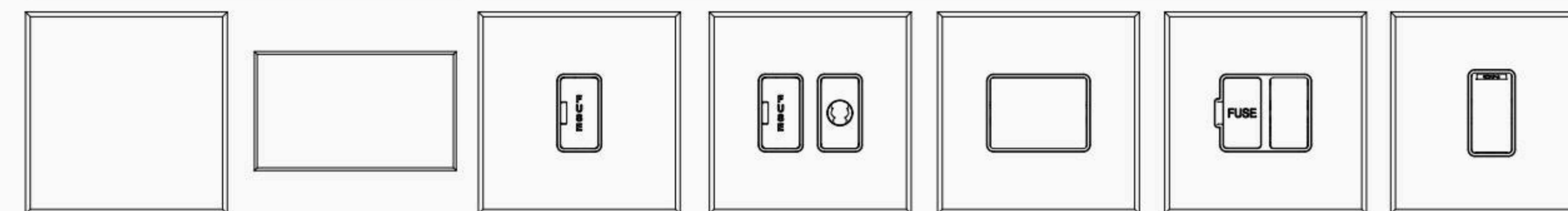

SINGLE BLANK PLATE
Code: PLT501
From: £65

DOUBLE BLANK PLATE
Code: PLT502
From: £85

DP UNSWITCHED FUSED SPUR
Code: ISG131
From: £81

DP UNSWITCHED FUSED SPUR FLEX OUTLET
Code: ISG132
From: £93

10A EXTRACTOR FAN ISOLATOR
Code: ISO101
From: £80

13A DP SWITCHED FUSED SPUR
Code: ISO133
From: £93

1 GANG 45A DP SWITCH - SINGLE
Code: ISO451
From: £72

Euro Plates

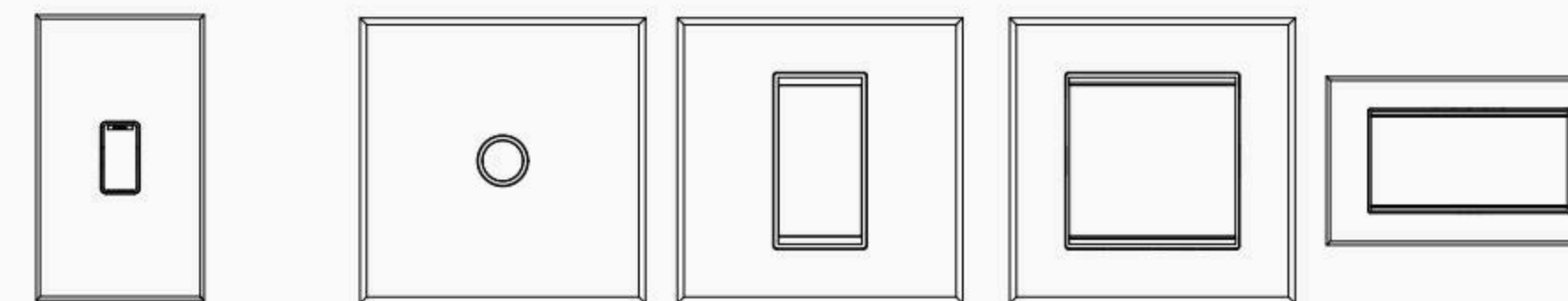

1 GANG 45A DP SWITCH - DOUBLE
Code: ISO453
From: £113

20A FLEX OUTLET
Code: PLT421
From: £68

1 X 25MM EM EURO MODULE WALL PLATE
Code: PLT401
From: £66

2 X 25MM EM EURO MODULE WALL PLATE
Code: PLT402
From: £65

4 X 25MM EM EURO MODULE WALL PLATE
Code: PLT404
From: £90

EXPLORE OUR CUSTOM-MADE SWITCH & SOCKET OPTIONS

For Endless Possibilities

Through our highly flexible and adaptable plate systems, coupled with an extensive range of grid modules, we've made sure that you never have to compromise on aesthetics or functionality.

Our flexible grid systems offer over 10,000 unique plate/switch combinations, readily available for next-day delivery.

Whether you're matching round aperture grid modules for toggle and dimmer switches or rectangular grid modules for rocker switches, the possibilities are endless - all on a single plate.

For customizable sockets, explore our wealth of euro plates and modules for one-of-a-kind sockets to suit your exact specifications.

Soho Combi-Grid® A Revolution in Choice

Not only have we meticulously crafted an extensive selection of products for each of our collections, we have pioneered the development of a proprietary combination grid system: the Soho Combi-Grid®. This innovation allows for the seamless integration of toggle, dimmer and rocker switches of any type and in any combination on a single plate, accommodating from one to 12 switch modules.

Front Loading Simplicity

At The Soho Lighting Company, we prioritise ease of installation. That's why all our grid frames are front loading. This ingenious design simplifies the installation process. Each module can be easily wired in and then securely clipped into place before the final touch - a flawless finish screwless faceplate - is fitted.

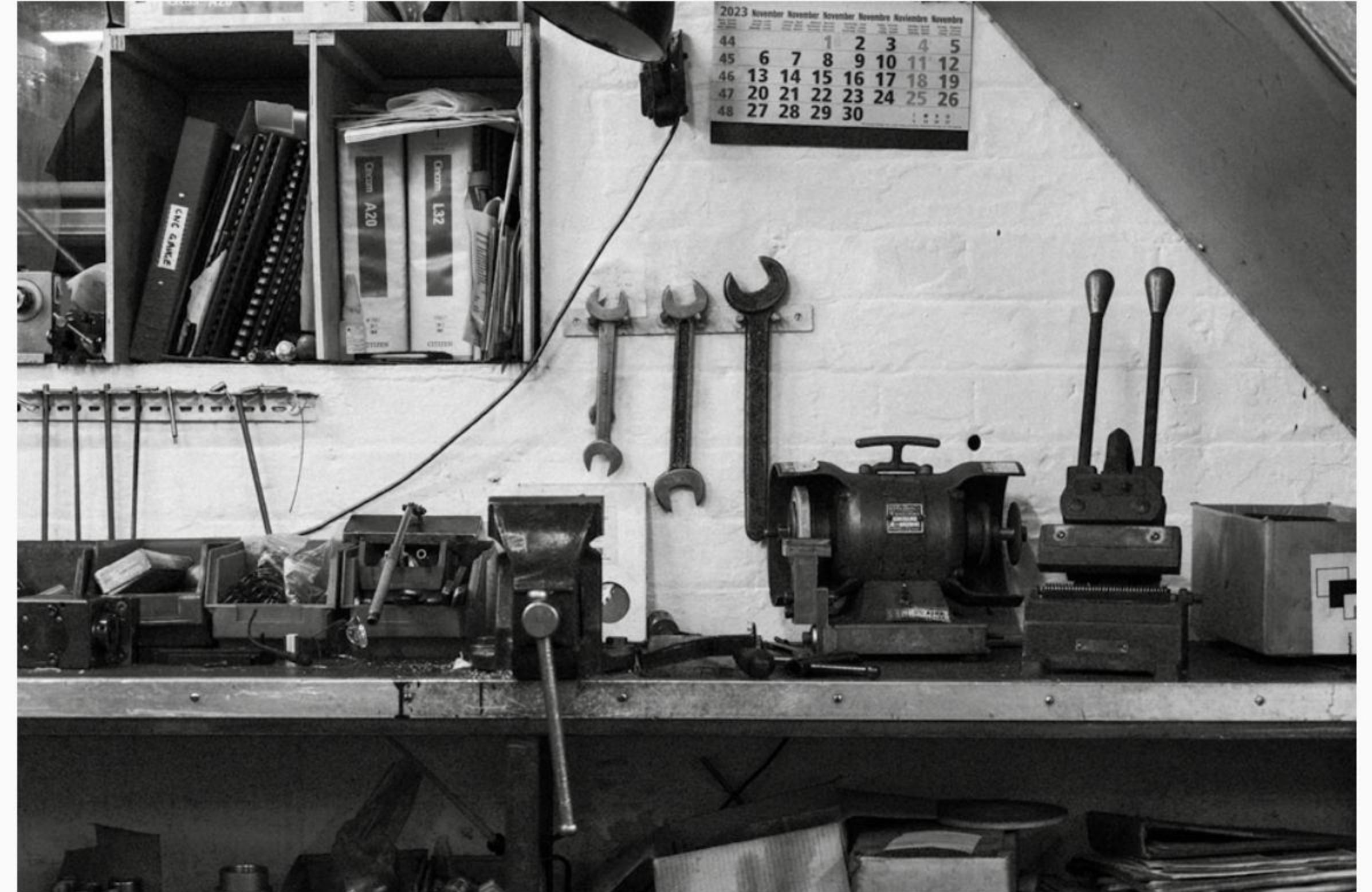

Grid Plates

CM Plate

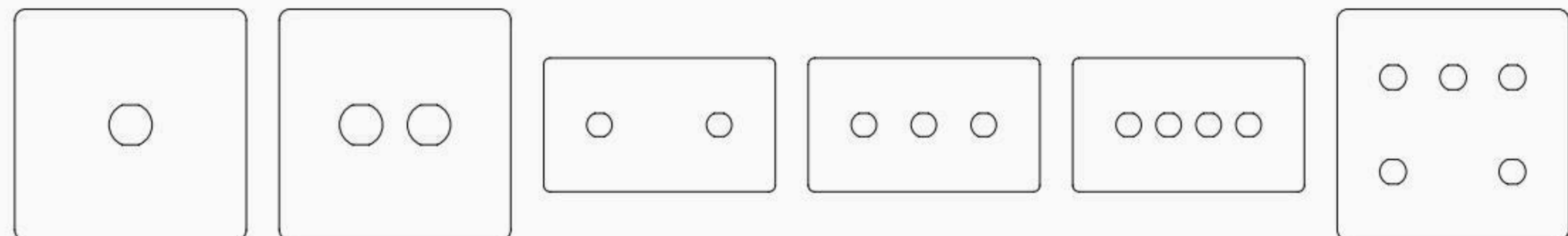

1 GANG CM CIRCULAR MODULE GRID PLATE
Code: GRD132
From: £13.97

2 GANG CM CIRCULAR MODULE GRID PLATE
Code: GRD133
From: £13.97

2 GANG (LG) CM CIRCULAR MODULE GRID PLATE
Code: GRD134
From: £13.97

3 GANG CM CIRCULAR MODULE GRID PLATE
Code: GRD135
From: £20

4 GANG CM CIRCULAR MODULE GRID PLATE
Code: GRD136
From: £20

5 GANG CM CIRCULAR MODULE GRID PLATE
Code: GRD137
From: £31

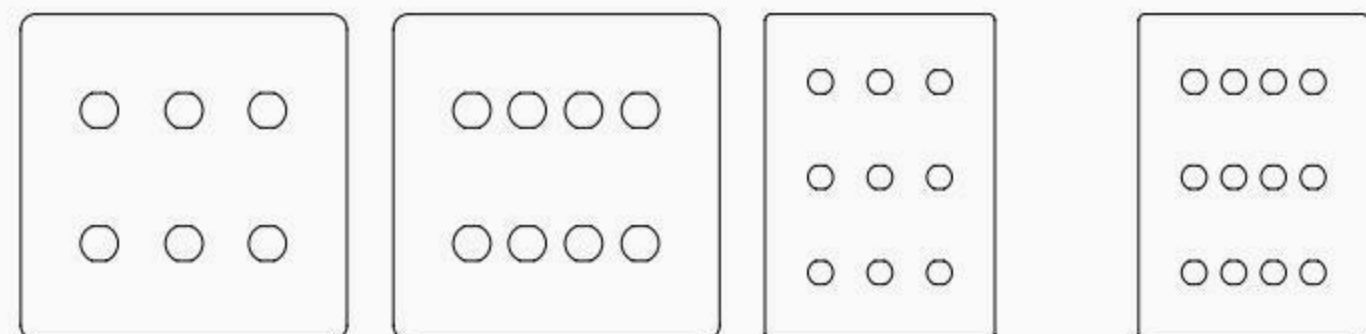

6 GANG CM CIRCULAR MODULE GRID PLATE
Code: GRD138
From: £31

8 GANG CM CIRCULAR MODULE GRID PLATE
Code: GRD139
From: £31

9 GANG CM CIRCULAR MODULE GRID PLATE
Code: GRD140
From: £80

12 GANG CM CIRCULAR MODULE GRID PLATE
Code: GRD141
From: £80

RM Plate

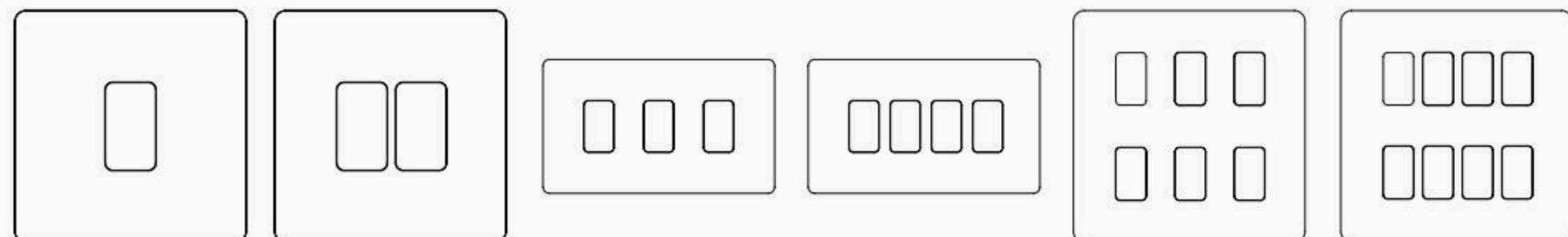

1 GANG RM RECTANGULAR MODULE GRID PLATE
Code: GRD101
From: £11.08

2 GANG RM RECTANGULAR MODULE GRID PLATE
Code: GRD102
From: £12.67

3 GANG RM RECTANGULAR MODULE GRID PLATE
Code: GRD103
From: £18

4 GANG RM RECTANGULAR MODULE GRID PLATE
Code: GRD104
From: £18

6 GANG RM RECTANGULAR MODULE GRID PLATE
Code: GRD106
From: £28

8 GANG RM RECTANGULAR MODULE GRID PLATE
Code: GRD108
From: £28

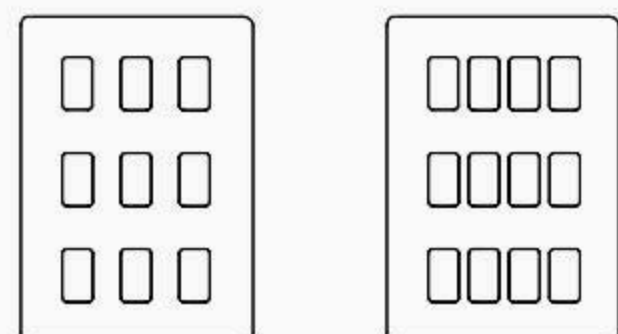

9 GANG RM RECTANGULAR MODULE GRID PLATE
Code: GRD109
From: £33

12 GANG RM RECTANGULAR MODULE GRID PLATE
Code: GRD112
From: £20

Dual Module Plate

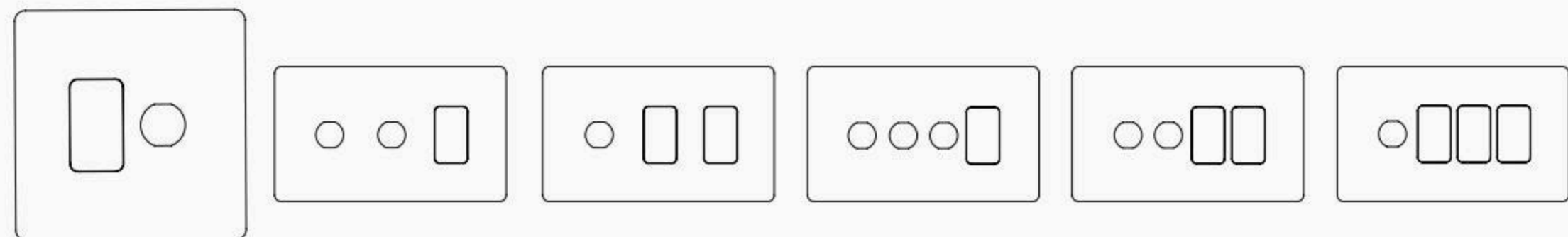

2 GANG 1RM+1CM DUAL MODULE GRID PLATE
Code: GRD120
From: £13.97

3 GANG 1RM+2CM DUAL MODULE GRID PLATE
Code: GRD121
From: £13.97

3 GANG 2RM+1CM DUAL MODULE GRID PLATE
Code: GRD122
From: £20

4 GANG 1RM+3CM DUAL MODULE GRID PLATE
Code: GRD124
From: £20

4 GANG 1RM+3CM DUAL MODULE GRID PLATE
Code: GRD125
From: £20

4 GANG 3RM+1CM DUAL MODULE GRID PLATE
Code: GRD126
From: £20

Dual Module Plate

continued

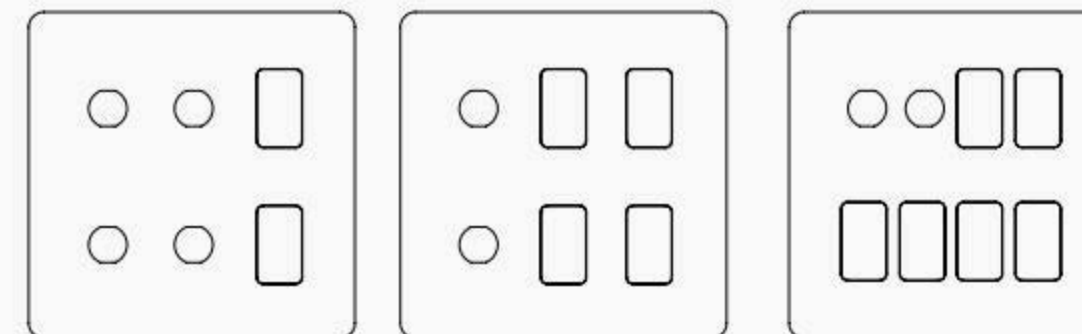

6 GANG 2RM+4CM DUAL MODULE GRID PLATE
Code: GRD127
From: £31

6 GANG 4RM+2CM DUAL MODULE GRID PLATE
Code: GRD128
From: £31

8 GANG 4RM+4CM DUAL MODULE GRID PLATE
Code: GRD130
From: £31

LT3 Toggle Plates

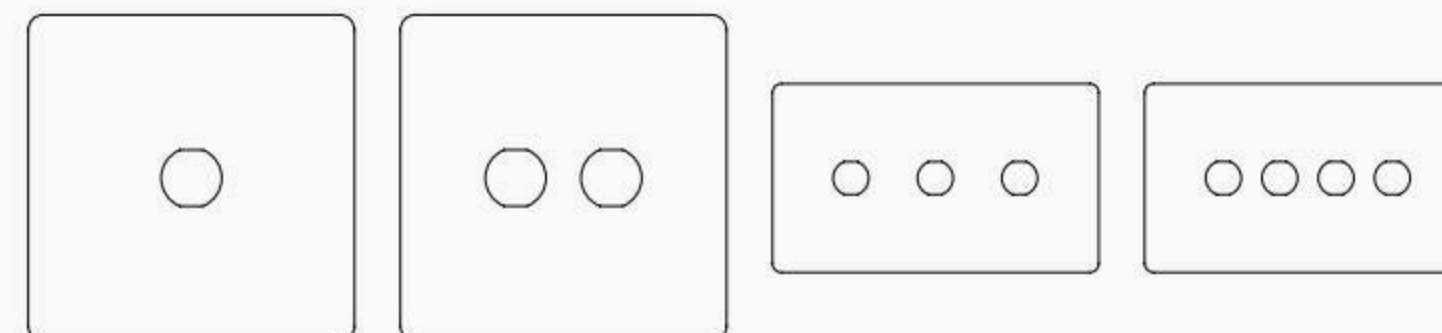

1 GANG LT3 TOGGLE PLATE
Code: PLT301
From: £19

2 GANG LT3 TOGGLE PLATE
Code: PLT302
From: £19

3 GANG LT3 TOGGLE PLATE
Code: PLT303
From: £26

4 GANG LT3 TOGGLE PLATE
Code: PLT304
From: £26

Grid Modules

CM Toggle Module

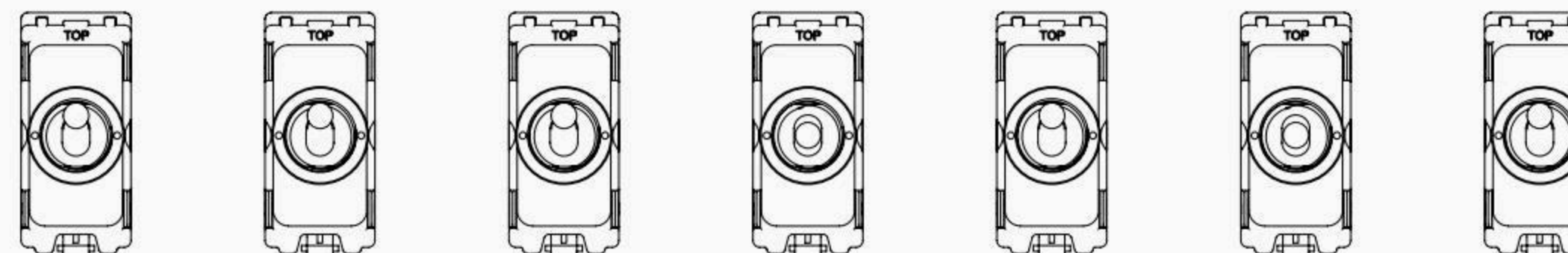

20A SP 2-WAY TOGGLE MODULE
Code: SGP310
From: £21

20A INTERMEDIATE TOGGLE MODULE
Code: SGP312
From: £27

20A DP TOGGLE MODULE
Code: SGP311
From: £24

20A 2 WAY & OFF TOGGLE SWITCH MODULE
Code: SGP313
From: £24

20A 2-WAY RETRACTIVE TOGGLE MODULE
Code: SGP314
From: £34

2-WAY & OFF RETRACTIVE TOGGLE MODULE
Code: SGP315
From: £34

1 WAY RETRACTIVE TOGGLE SWITCH MODULE
Code: SGP316
From: £26

CM Rotary Module

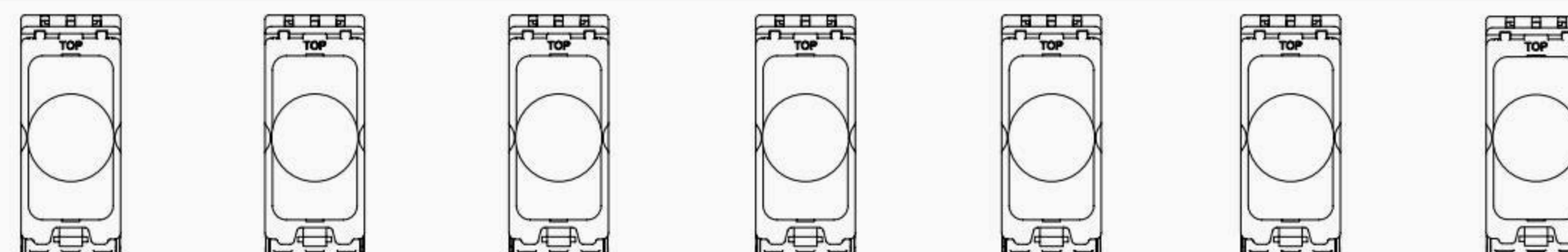

150W LED DIMMER MODULE
Code: SGP144
From: £37

400W LED DIMMER MODULE
Code: SGP152
From: £45

250W LED MULTI-WAY DIMMER MODULE
Code: SGP153
From: £53

1000W LED DC1-10V DIMMER MODULE
Code: SGP154
From: £32

6A DUMMY DIMMER SWITCH MODULE
Code: SGP145
From: £24

1000W DUMMY DIMMER SWITCH MODULE
Code: SGP155
From: £11.99

1000W INTERMEDIATE DUMMY DIMMER MODULE
Code: SGP160
From: £18

CM Push Module

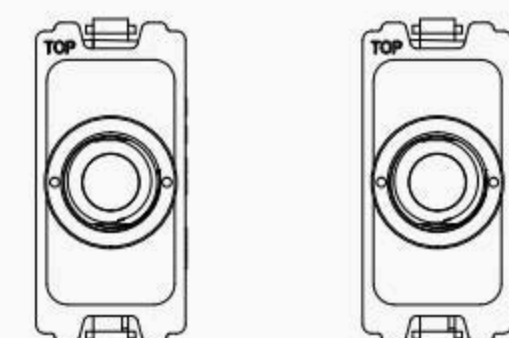

2 WAY PUSH BUTTON CM MODULE SWITCH
Code: SGP501
From: £19

2 WAY RETRACTIVE PUSH BUTTON CM MODULE
Code: SGP211
From: £19

RM Rotary Module

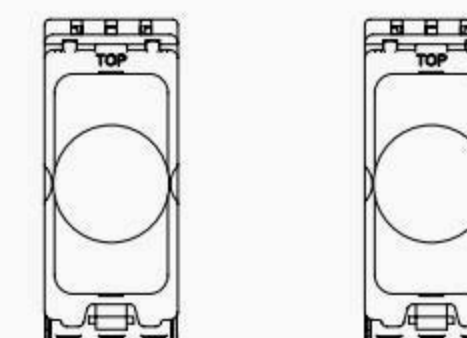

150W LED DIMMER MODULE
Code: SGP141
From: £33

6A DUMMY DIMMER SWITCH MODULE
Code: SGP142
From: £16

RM Rocker Module

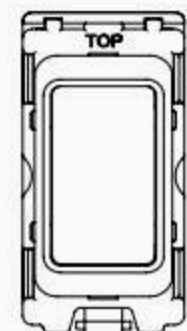

20AX 2 WAY SWITCH MODULE
Code: SGP201
From: £5.77

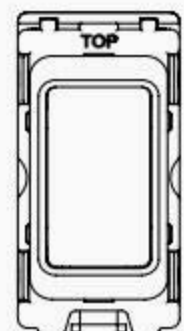

20AX 2 WAY AND OFF SWITCH MODULE
Code: SGP202
From: £8.08

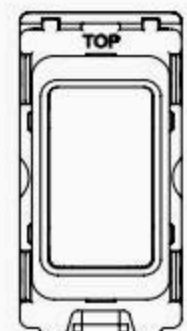

20AX INTERMEDIATE SWITCH MODULE
Code: SGP203
From: £7.97



1 WAY RETRACTIVE SWITCH MODULE
Code: SGP204
From: £9.47

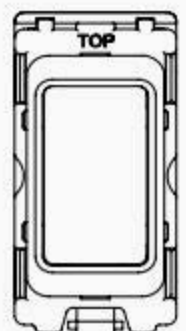

2 WAY RETRACTIVE SWITCH MODULE
Code: SGP205
From: £9.47



2 WAY OFF RETRACTIVE SWITCH MODULE
Code: SGP208
From: £11.38



2 WAY RETRACTIVE 'BELL' SWITCH MODULE
Code: SGP206
From: £11.38

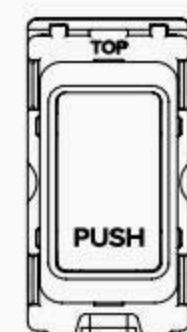

2 WAY RETRACTIVE 'PUSH' SWITCH MODULE
Code: SGP207
From: £11.38

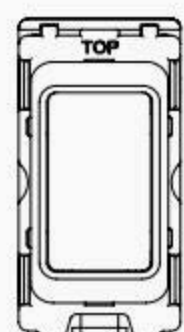

20A DP SWITCH MODULE
Code: SGP209
From: £9.88

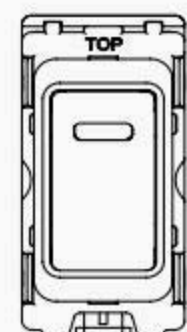

20A DP SWITCH MODULE WITH NEON
Code: SGP212
From: £11.38

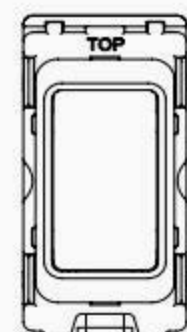

20A 1 WAY DP RETRACTIVE SWITCH MODULE
Code: SGP213
From: £10.07



10A TRIPLE POLE FAN ISOLATOR SWITCH MODULE
Code: SGP407
From: £11.38



20A DP 'COFFEE MACHINE' SWITCH MODULE
Code: SGP221
From: £6.37



20A DP 'COOKER HOOD' SWITCH MODULE
Code: SGP222
From: £6.37

RM Module

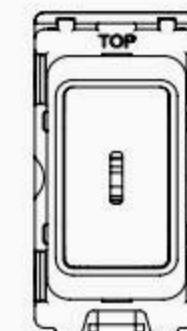

20AX 2 WAY SP KEY SWITCH MODULE
Code: SGP210
From: £8.47

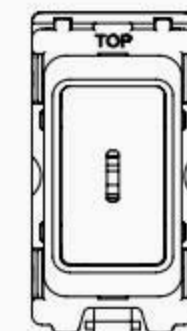

20AX DP KEY SWITCH MODULE
Code: SGP243
From: £8.47



BLANK SWITCH MODULE
Code: SGP401
From: £8.47



FLEX OUTLET SWITCH MODULE
Code: SGP402
From: £5.08

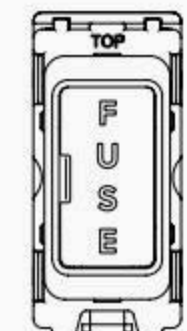

FUSED CONNECTION UNIT SWITCH MODULE
Code: SGP403
From: £3.77

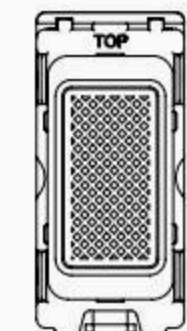

GREEN INDICATOR SWITCH MODULE
Code: SGP404
From: £3.77

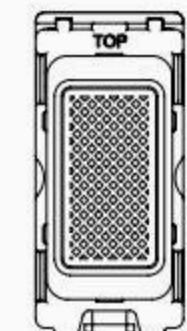

ORANGE INDICATOR SWITCH MODULE
Code: SGP405
From: £9.47

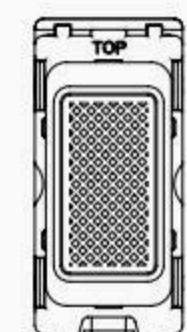

RED INDICATOR SWITCH MODULE
Code: SGP406
From: £9.47



20A DP 'DISHWASHER' SWITCH MODULE
Code: SGP223
From: £6.37



20A DP 'FAN' SWITCH MODULE
Code: SGP224
From: £6.37



20A DP 'FREEZER' SWITCH MODULE
Code: SGP225
From: £6.37



20A DP 'FRIDGE' SWITCH MODULE
Code: SGP226
From: £6.37



20A DP 'HOB' SWITCH MODULE
Code: SGP227
From: £6.37



20A DP KEY SWITCH MODULE
Code: SGP228
From: £8.47

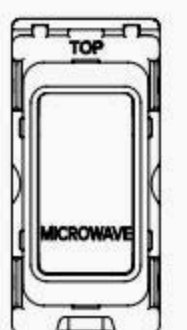

20A DP 'MICROWAVE' SWITCH MODULE
Code: SGP229
From: £6.37



20A DP 'OVEN' SWITCH MODULE
Code: SGP230
From: £6.37



20A DP 'TUMBLE DRYER' SWITCH MODULE
Code: SGP231
From: £6.37



20A DP 'WASHER DRYER' SWITCH MODULE
Code: SGP232
From: £6.37



20A DP 'WASHING MACHINE' SWITCH MODULE
Code: SGP233
From: £6.37



20A DP 'WINE COOLER' SWITCH MODULE
Code: SGP234
From: £6.37



20A DP 'WARMER DRAWER' SWITCH MODULE
Code: SGP235
From: £6.37

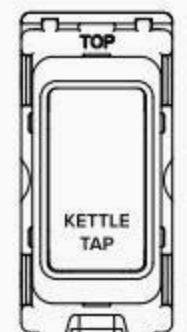

20A DP 'KETTLE TAP' SWITCH MODULE
Code: SGP236
From: £6.37

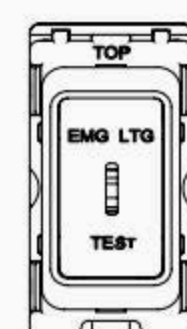

20AX 2 WAY SP 'EMG LTG TEST' SWITCH MODULE
Code: SGP241
From: £10.18

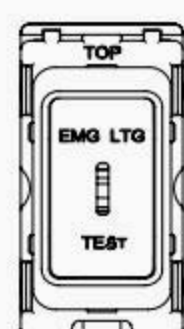

20AX DP 'EMG LTG TEST' SWITCH MODULE
Code: SGP242
From: £10.18

LT3 Toggle Modules



20AX 2 WAY TOGGLE SWITCH MODULE
Code: SGP301
From: £19



20A DOUBLE POLE TOGGLE SWITCH MODULE
Code: SGP302
From: £22



20AX INTERMEDIATE TOGGLE SWITCH MODULE
Code: SGP303
From: £25



20A 2 WAY & OFF TOGGLE SWITCH MODULE
Code: SGP304
From: £22



20A 2 WAY RETRACTIVE TOGGLE SWITCH MODULE
Code: SGP305
From: £31



20A 2 WAY & OFF RETRACTIVE TOGGLE SWITCH MODULE
Code: SGP307
From: £31



20A 1 WAY RETRACTIVE TOGGLE SWITCH MODULE
Code: SGP309
From: £29

Euro Module Plates

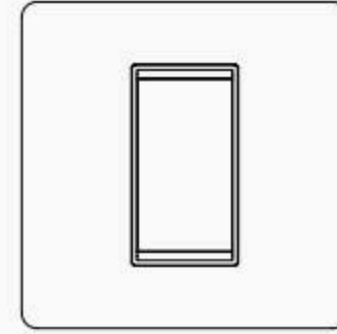

**SINGLE PLATE 1
MODULE EURO
MODULE WALL PLATE**
Code: PLT401
From: £17

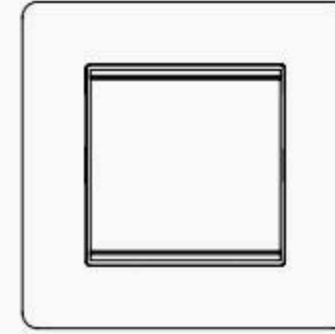

**SINGLE PLATE 2
MODULE EURO
MODULE WALL PLATE**
Code: PLT402
From: £18

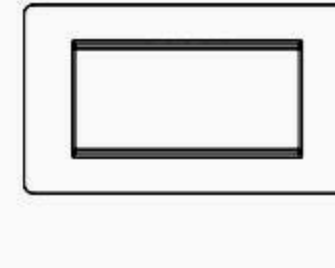

**DOUBLE PLATE 4
MODULE EURO
MODULE WALL PLATE**
Code: PLT404
From: £23

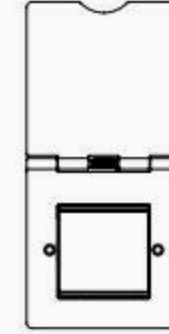

**SINGLE PLATE EURO
MODULE FLOOR PLATE**
Code: PLT411
From: £20

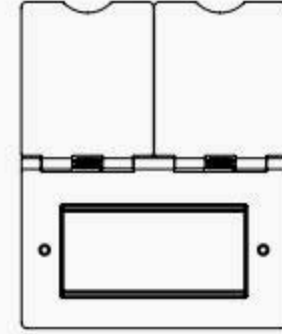

**DOUBLE PLATE EURO
MODULE FLOOR PLATE**
Code: PLT412
From: £19.98

Euro Modules

Socket

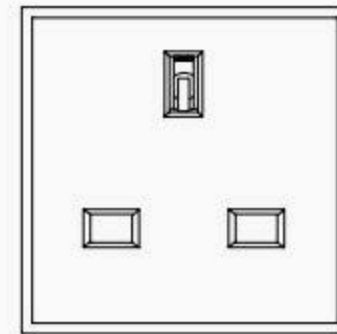

13A SOCKET MODULE
Code: EMD501
From: £5.27

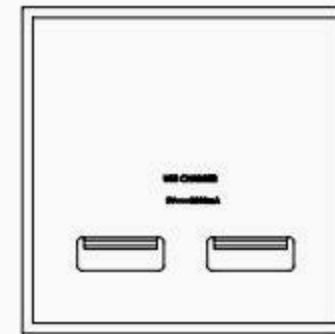

**USB CHARGER 2 GANG
MODULE**
Code: EMD401
From: £26



**USB CHARGER A+C
MODULE**
Code: EMD403
From: £28



**USB CHARGER
3.6A MODULE**
Code: EMD412
From: £23

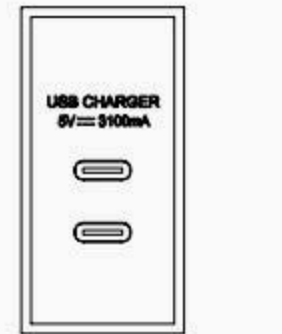

**USB FAST CHARGER
C+C MODULE**
Code: EMD413
From: £31

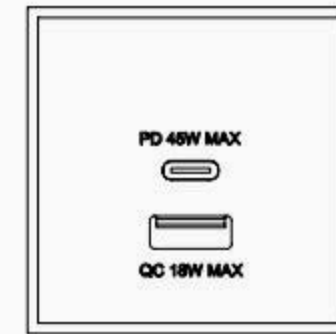

**USB FAST CHARGER
A+C MODULE**
Code: EMD422
From: £28

Media

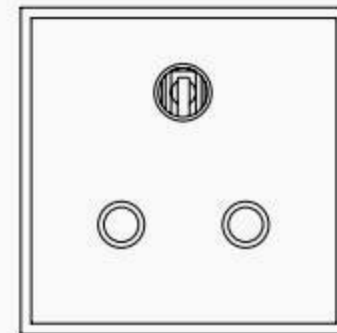

5A SOCKET MODULE
Code: EMD502
From: £5.27

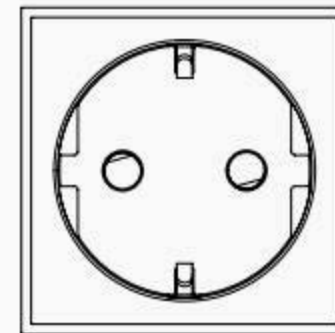

**16A SCHUKO SOCKET
MODULE**
Code: EMD160
From: £5.27

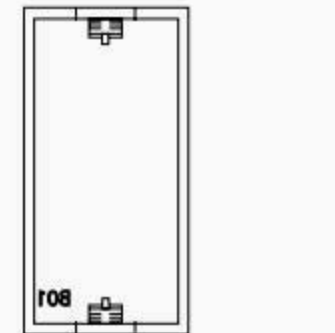

BLANK MODULE
Code: EMD601
From: £1.87

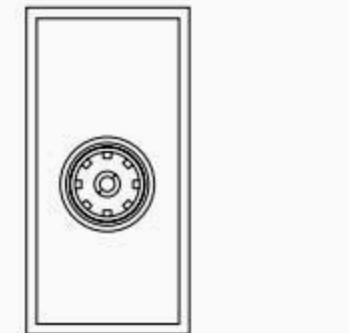

**TV OUTLET (FE)
MODULE**
Code: EMD101
From: £6.07

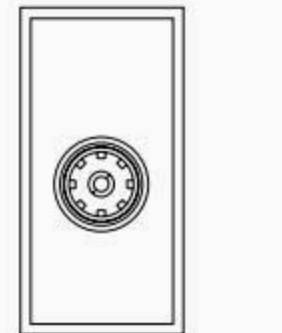

**F CONNECTOR
(SCREENED) MODULE**
Code: EMD102
From: £6.07

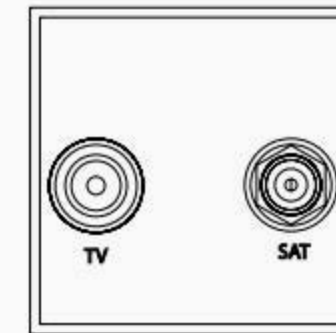

TV/SAT MODULE
Code: EMD103
From: £10.87

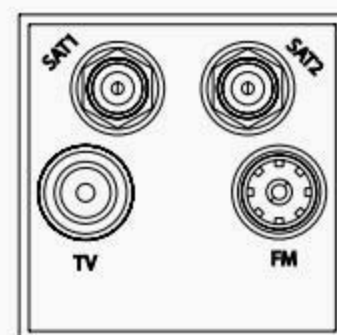

**SAT1/SAT2/TV/RADIO
MODULE**
Code: EMD105
From: £16

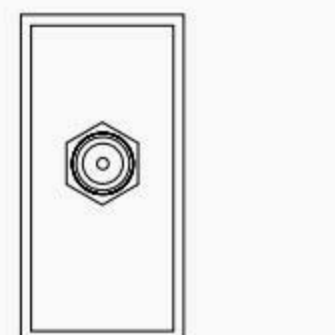

**TERMINAL F
CONNECTOR MODULE**
Code: EMD104
From: £2.87

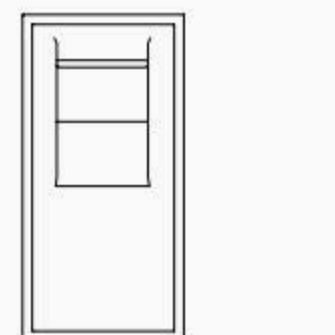

**BT MASTER TELEPHONE
SOCKET MODULE**
Code: EMD201
From: £6.37

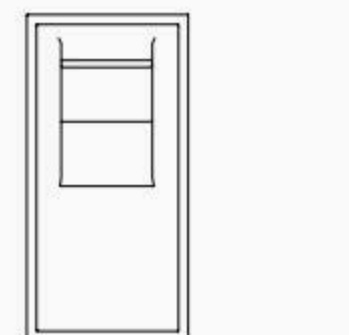

**BT SECONDARY
TELEPHONE SOCKET
MODULE**
Code: EMD202
From: £4.18

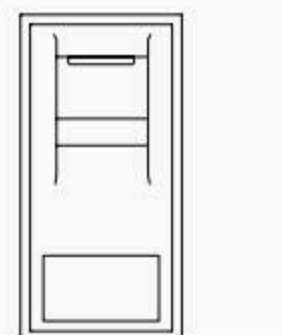

RJ45 CAT5E MODULE
Code: EMD301
From: £5.17

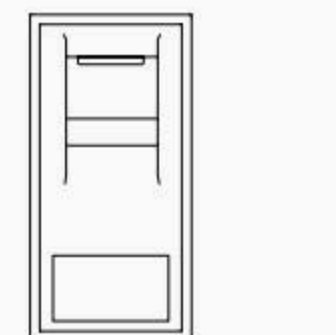

RJ45 CAT6 MODULE
Code: EMD302
From: £6.28

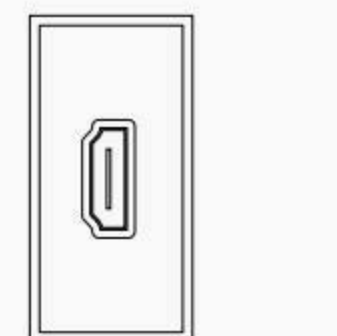

**HDMI MOUNTED
SOCKET MODULE**
Code: EMD111
From: £16

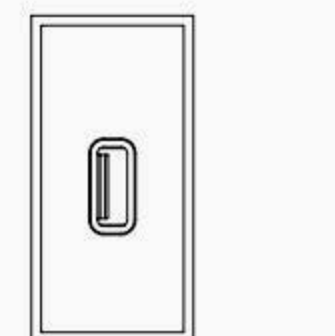

**USB MOUNTED
SOCKET MODULE**
Code: EMD402
From: £16

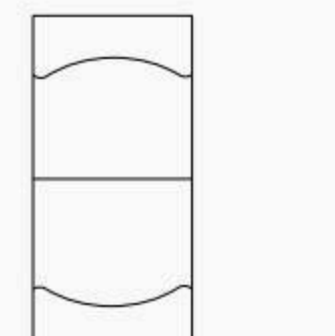

**BRUSH SINGLE
MODULE**
Code: EMD602
From: £3.77

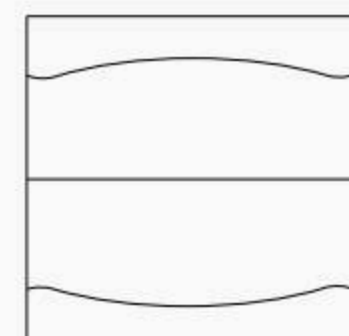

**BRUSH DOUBLE
MODULE**
Code: EMD603
From: £5.27

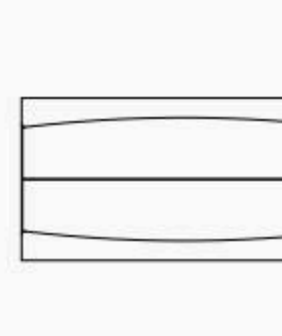

BRUSH 4X MODULE
Code: EMD604
From: £6.37

Grid Plates

TM Grid
Plates - HRP

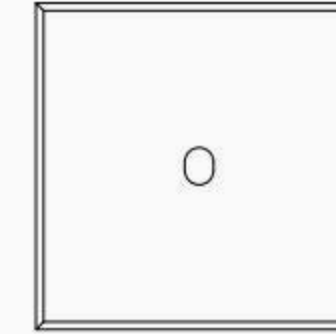

**1 GANG GRID SWITCH
PLATE**
Code: GRD151
From: £66

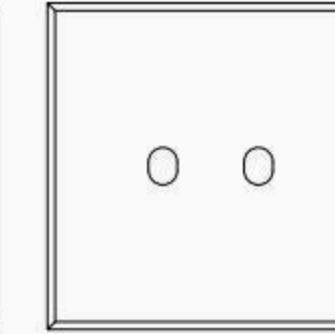

**2 GANG GRID SWITCH
PLATE**
Code: GRD152
From: £66

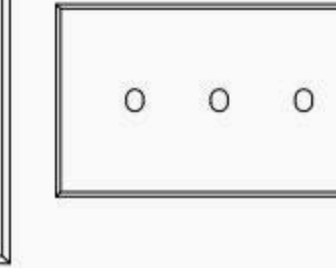

**3 GANG GRID SWITCH
PLATE**
Code: GRD153
From: £84

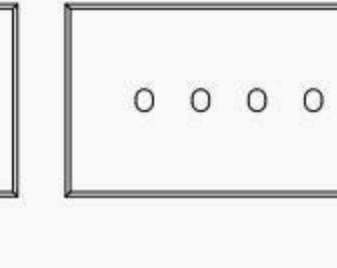

**4 GANG GRID SWITCH
PLATE**
Code: GRD154
From: £84

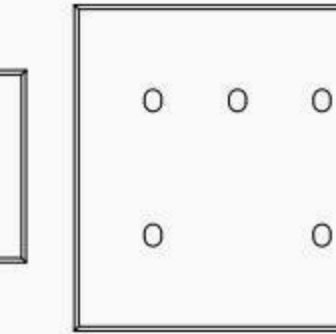

**5 GANG GRID SWITCH
PLATE**
Code: GRD155
From: £140

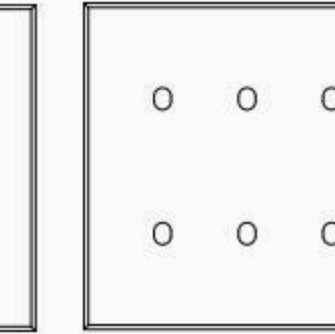

**6 GANG GRID SWITCH
PLATE**
Code: GRD156
From: £124

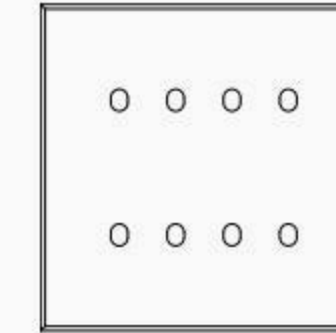

**8 GANG GRID
SWITCH PLATE**
Code: GRD157
From: £124

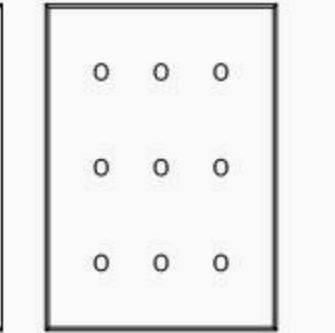

**9 GANG GRID
SWITCH PLATE**
Code: GRD158
From: £162

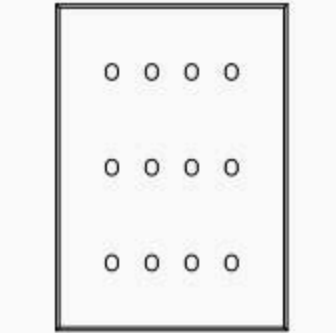

**12 GANG GRID
SWITCH PLATE**
Code: GRD159
From: £162

TM Grid
Modules - HRP



**20A SP 2-WAY GRID
TOGGLE MODULE**
Code: SGP310
From: £19



**20A DP GRID
TOGGLE MODULE**
Code: SGP311
From: £20



**20A INTERMEDIATE
GRID TOGGLE MODULE**
Code: SGP312
From: £21



**20A 2-WAY
RETRACTIVE GRID
TOGGLE MODULE**
Code: SGP314
From: £20

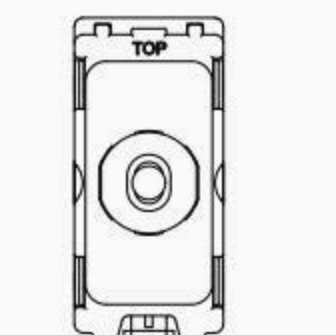

**2-WAY & OFF
RETRACTIVE GRID
TOGGLE MODULE**
Code: SGP315
From: £20



THE SOHO LIGHTING CO.

Wall colour: Lilac Pink by Edward
Bulmer Natural Paint

Lighting the way

Alongside our switches and sockets, we offer an extensive collection of beautiful lighting inspired by period properties and designed for modern living.

From decorative pendants and wall lights, statement showstoppers, elegant bathroom and solid brass outdoor lighting, plus innovative sustainable designs, downlights and bulbs, each collection is meticulously designed and backed by cutting edge technology. Explore our entire lighting at soholighting.com

P. 95



SOHOLIGHTING.COM



Become a Trade Member

If you are an Interior Designer, Architect/Specifier, Electrical Contractor or fit-out contractor for retail or commercial projects, then membership of our trades programme gives you unrivalled benefits including:

- Trade rates across our full product portfolio of 2000 quality branded products
- Automatic trade pricing on our website
- No minimum spend
- 28 day no quibble returns policy
- Responsive personal account manager
- Large stock holdings
- Next day delivery on standard products
- Product customisation by design
- 100% free service to qualifying professionals and organisations
- Trade applications are confirmed within 24 hours



Keep in touch

Follow us on Insta



Subscribe to our newsletter



For all the latest from Soho Lighting, sign up to our Bright Ideas newsletter and follow us on Instagram for behind the scenes stories, lighting inspiration, product launches and more.

We love to see your Soho Lighting lights, switches and sockets in situ - please send us your photos and videos or tag us on Insta and we will be delighted to share them.

Contact Us



Online: at www.soholighting.com
Call: 0208 106 1221
Email: sales@soholighting.com
Showroom: Simpsons, G2 Design Centre East, London SW10 0XF

Please note that prices are correct at time of print, but may be subject to change.

S O
H O